

Application Note

No.4-1E



Operational Guide for
-TR-9305
Digital Spectrum Analyzer



TakedaRiken

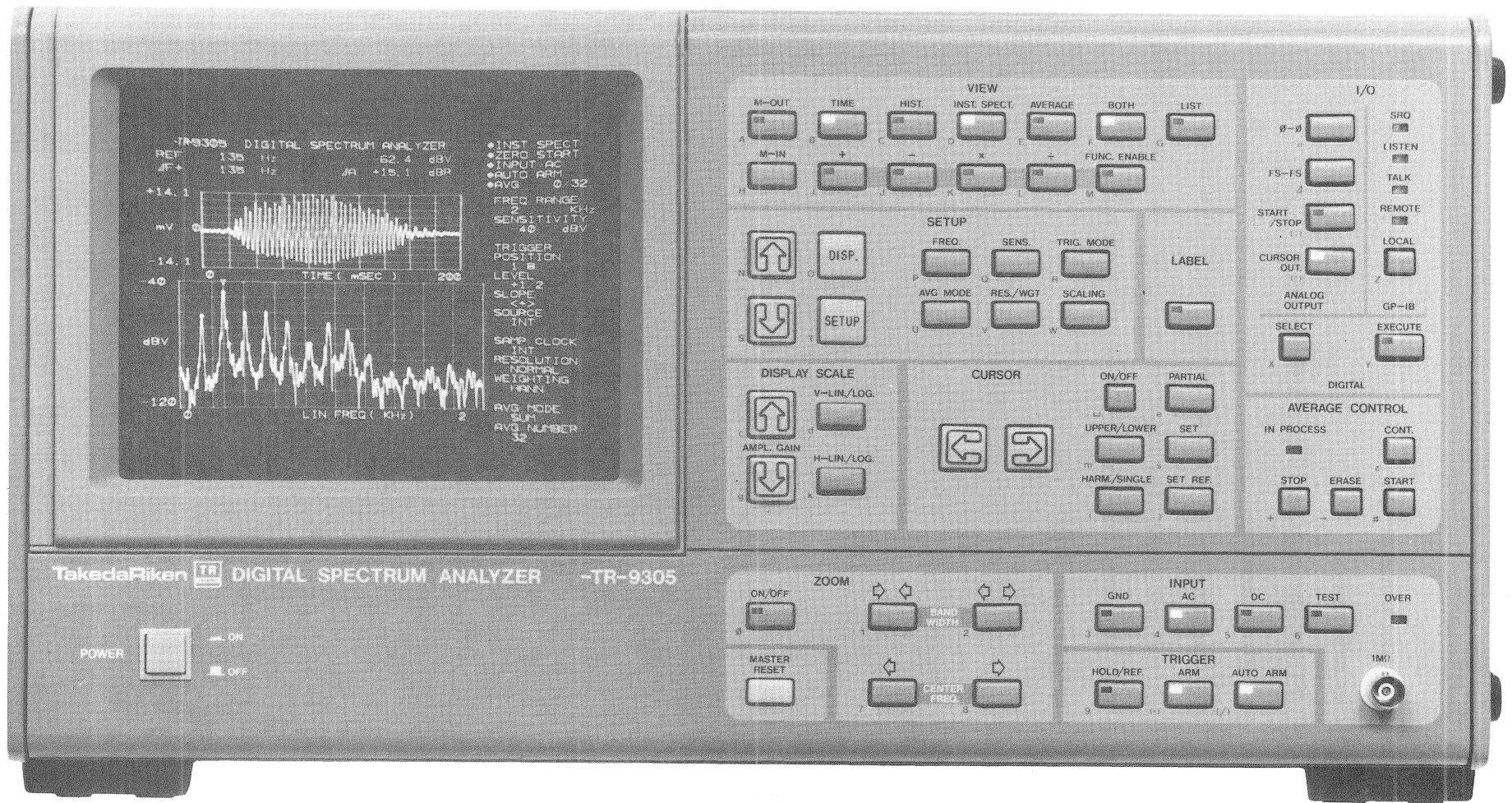

Fig. 1 -TR-9305 Digital Spectrum Analyzer

The -TR-9305 Digital Spectrum Analyzer functions as:

- Spectrum analyzer
- Oscilloscope
- Transient memory (Digital oscilloscope)
- Signal averager
- Histogram meter (Probability density function meter)
- Frequency counter (Frequency meter and time interval meter)
- Digital voltmeter (Voltmeter and RMS meter)
- Distortion meter

Fig. 2

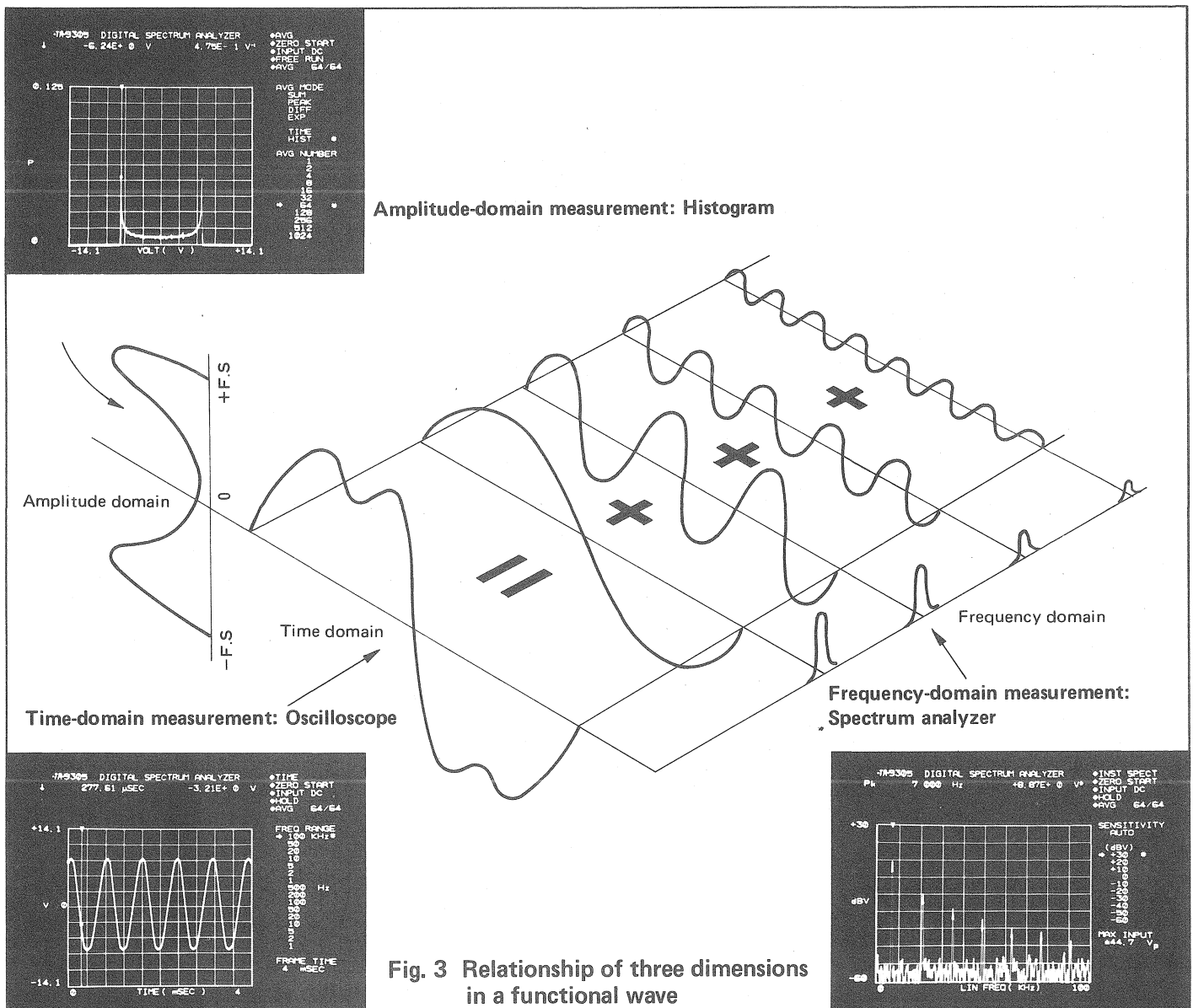

Fig. 3 Relationship of three dimensions in a functional wave

Applications

● Machinery industry

- Vibration and noise analysis of automobiles
- Vibration analysis of airborne and aerospace instruments, and vibration data analysis in wind tunnel experiments
- Study of vehicle vibration and noise problem
- Vibration analysis of turbine blades and other components
- Monitoring of turning machines for prevention of destruction
- Analysis of machine tool judder
- Vibration and noise reduction of civil engineering and construction machines
- Core motion monitoring of pressurized water reactors
- Dynamic analysis of earthquake-proof dams, bridges and buildings.
- Analysis of acoustic emission
- Waveform analysis and spectrum analysis in impact test
- Education and study of vibration and noise in colleges and other educational organizations

● Acoustics

- Performance test of speakers and audio equipment
- Analysis of frequency transfer characteristics, reverberation and sound insulation characteristics
- Sound analysis and sound field measurement
- Wow/flutter analysis of audio and video equipment.
- Distortion test of speakers and amplifiers
- Frequency response and noise analysis of linear ICs and analog circuits

● Medicine

- Impulse analysis of brain wave and muscles under stress
- Histogram analysis of heart beat period.

● Chemistry

- Signal analysis in nuclear magnetic resonance (NMR), electron spin resonance (ESR), Auger analysis, and photoelectronic analysis (ESCA)
- Improvement of S/N ratio for small signals in noise, and Fourier transformation

Fig. 4

Features

■ Abundant measuring capabilities

The instrument offers measuring capabilities in the time domain, frequency domain and amplitude domain which are three basic signal analysis. Real-time measurement and averaging measurement are possible in each domain.

■ Built-in zooming function as standard

Powerful digital filtering technology makes it possible to magnify an arbitrary portion by x2 to x128 for analysis of adjacent components of a spectrum.

■ High sensitivity, broad-band and wide dynamic range

Up to 100 kHz band can be measured over a calibrated wide amplitude range from +30 dBV to -120 dBV. The wide 70 dB dynamic range permits separation of a small signal in a large signal for measurement.

■ All information on CRT

The built-in large high precision CRT displays the measurement condition and user's label (such as data and operator's name) for hardcopy, in addition to the measured data. Measurement conditions can also be set through the "menu" displayed on the CRT.

■ Abundant analysis capabilities

- Any point on a spectrum can be digitally read out using a cursor.
- The memory function and dual display function enable accurate comparison between data and domain conversion by simultaneous display in the time and frequency domains.
- A wide variety of computation modes provides ΔT and ΔV in the time domain, Δf and ΔdB in the frequency domain, arithmetic operation of data, overall RMS display, automatic peak search, listing of the order of higher harmonics, and THD.
- Abundant averaging modes allow improvement of the S/N ratio and dynamic range, and extraction of very small signals.
- Abundant trigger modes and flexible trigger condition allow a transient phenomenon to be caught accurately.
- The display can be converted into industrial units by the scaling function.

Fig. 5

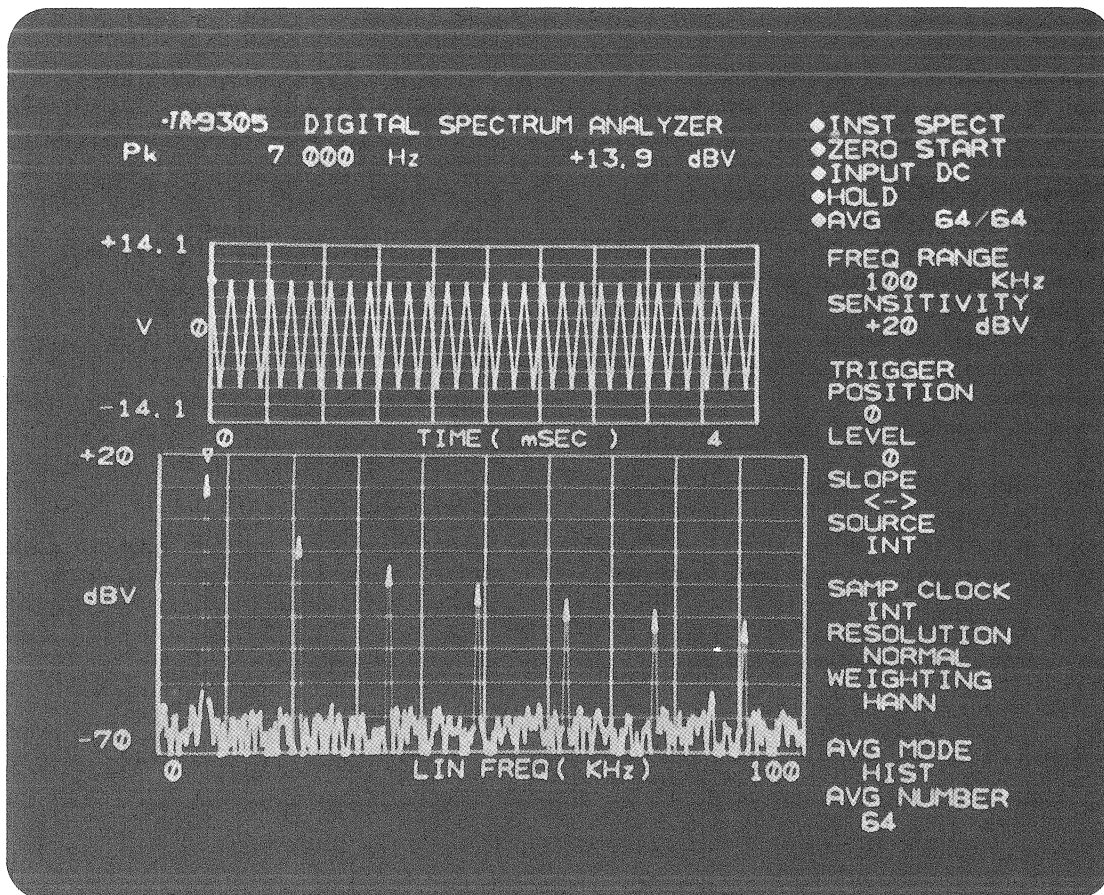

Fig. 6 CRT screen of -TR-9305 (full-scale size)

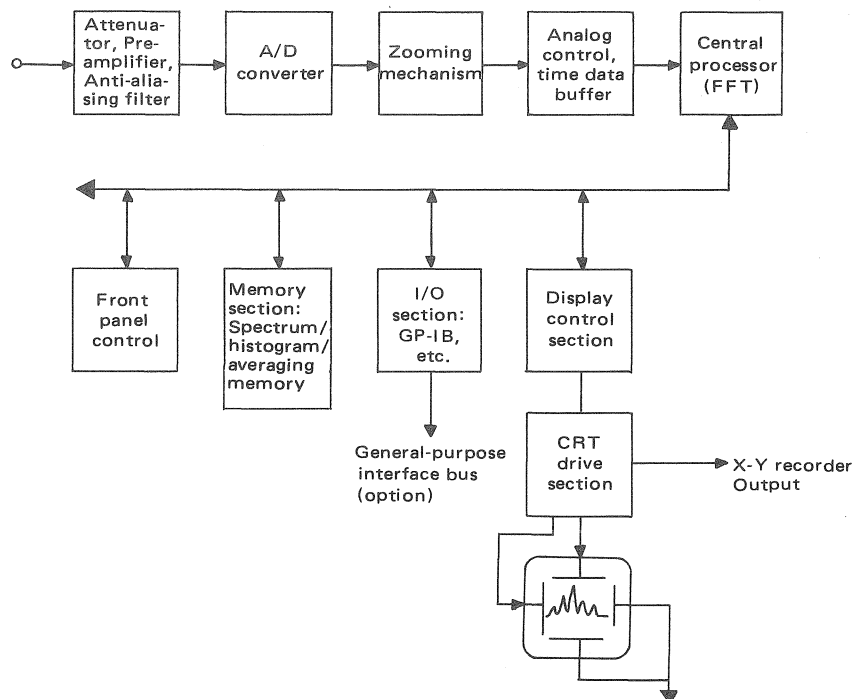
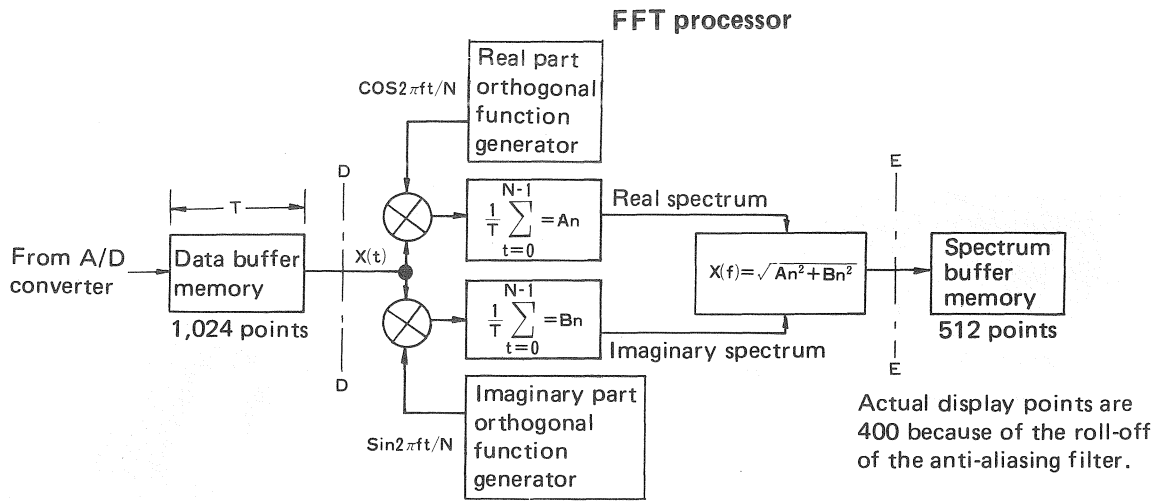

Fig. 7 -TR-9305 digital spectrum analyzer block diagram



- X(t): Finite number of time-serial data (time function);
the value of the t-th sample
- X(f): The f-th order complex finite Fourier coefficient
- A: Real part Fourier coefficient
- B: Imaginary part Fourier coefficient
- N: Number of data samples in the time domain
- T: Measurement time in the time domain (2π)

Fig. 8 Principle of digital Fourier transformer

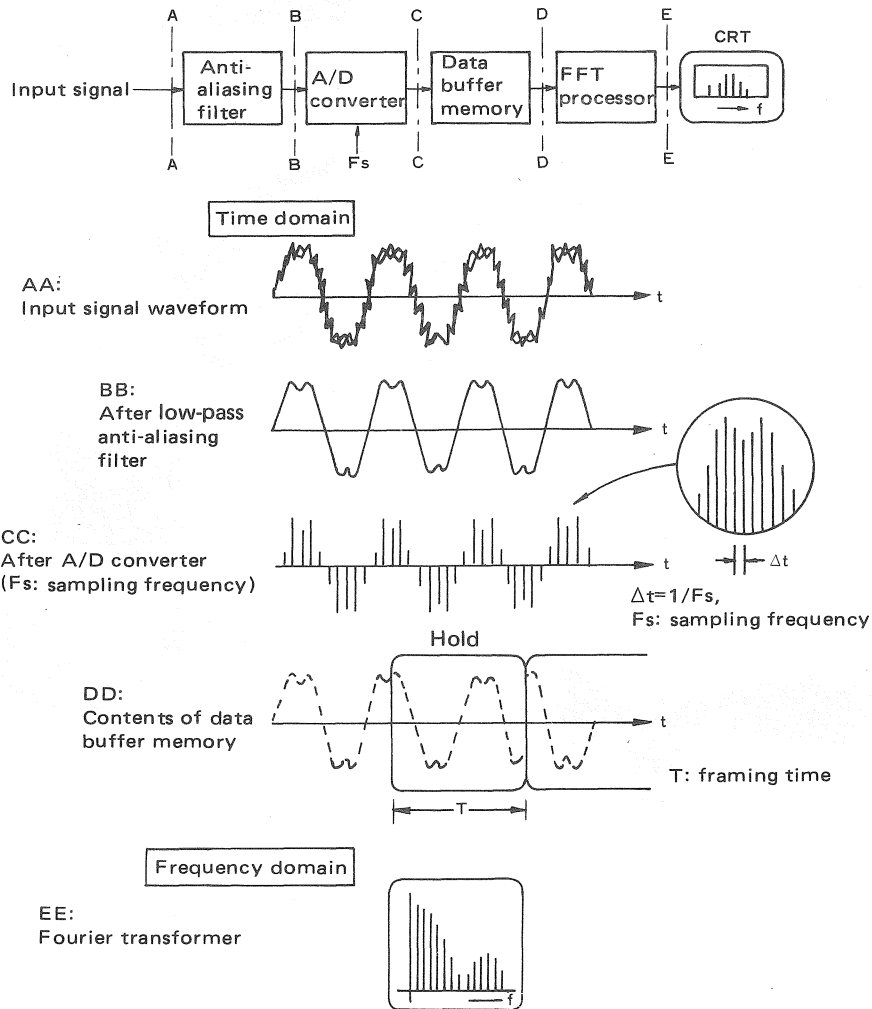

Fig. 9 Waveform in digital spectrum analyzer

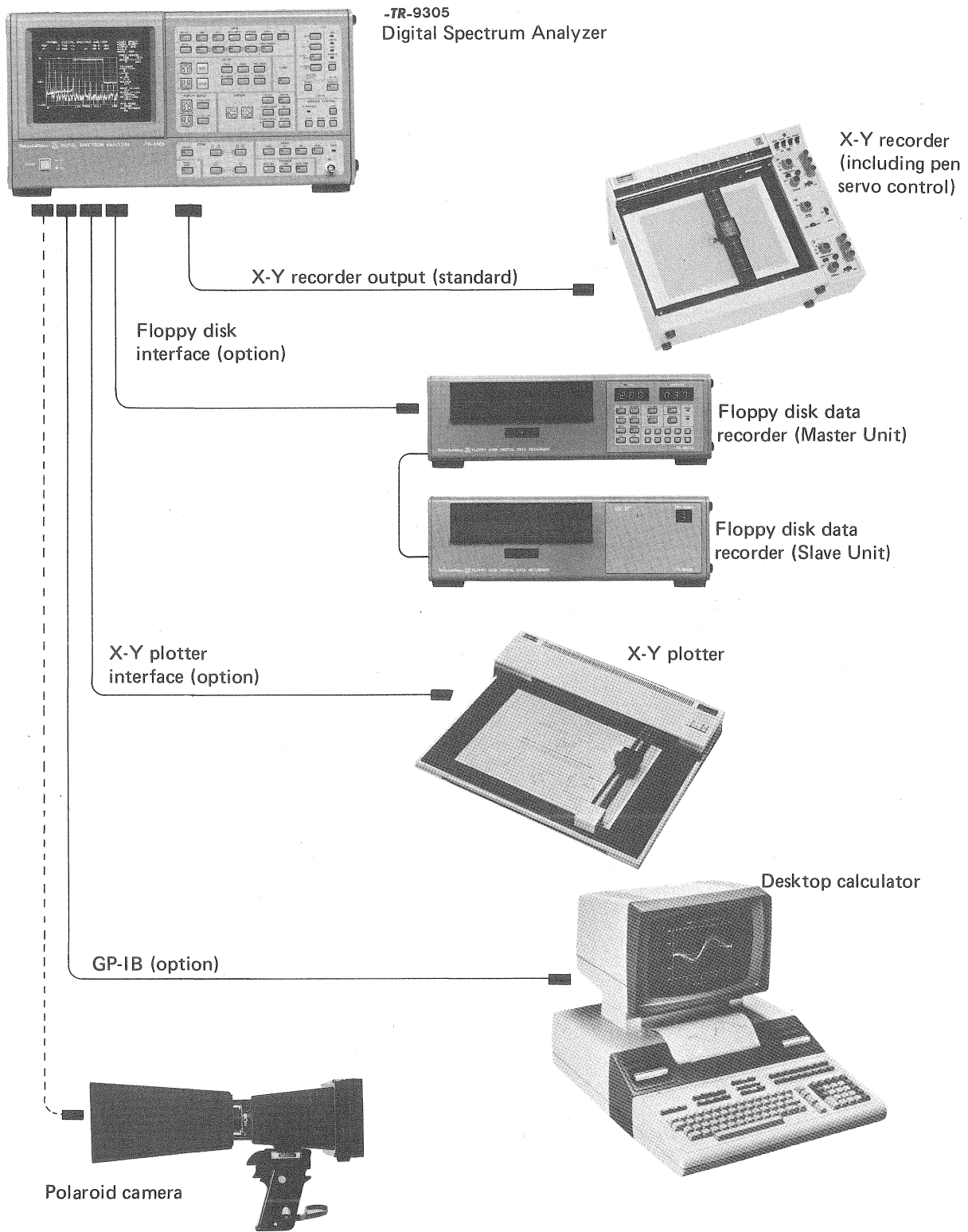

Fig. 10 System configuration with peripheral devices



Fig. 11 -TR-9801A Floppy Disk Master Unit



Fig. 12 -TR-9801B Floppy Disk Slave Unit



-TR-9801A

-TR-9305

Fig. 13 Combination of -TR-9305 and -TR-9801

**-TR-9801A/9801B
Floppy Disk Digital Data Recorder**

**(-TR-9801A Master Unit,
-TR-9801B Slave Unit)**

The **-TR-9801 A/9801 B** Floppy Disk Digital Data Recorder is designed as a large scale memory for the **-TR-9305** Digital Spectrum Analyzer. The **-TR-9801** and **-TR-9305**, combined to form a system, can analyze the vibration of a rotating member and variations of impact signals with time.

The system operates in a mode in which an input signal is stored by a self-trigger or external trigger signal, continuous

memorizing mode or manual memorizing mode, so that any of the frequency-domain data, time-domain data and amplitude-domain data displayed on the CRT of the **-TR-9305** can be stored at a high speed. Data stored in the **-TR-9801** can be reproduced on the CRT of the **-TR-9305** and can be recorded on a camera, X-Y recorder or X-Y plotter as a hard copy.

-TR-9801 / -TR-9305 system performance (tentative)

Connection: **-TR-9801** and **-TR-9305** are coupled using the optional interface board and cable (**-TR-9305** option 02)

System configuration: The **-TR-9801A** Master Unit can be connected up to three **-TR-9801B** Slave Units, for continuous memorizing and image reproduction.

Memory capacity: Approx. 200 units/medium, where

Frequency-domain data:	1 unit
Time-domain data:	2 units
Amplitude-domain data:	1 unit
List data:	1 unit

Examples: Approx. 200 frames/medium for frequency-domain data
Approx. 100 frames/medium for time-domain data

Memorizing and reproduction form: All information (measurement conditions, label and data) displayed on the CRT of the **-TR-9305** can be memorized and reproduced in both 1-unit and 2-unit modes.

Memorizing mode: Triggered memorizing mode, continuous memorizing

mode and manual memorizing mode

3-digit "TAG" number and 3-digit "SEQUENTIAL" number are attached to the stored data, and the data can be called by the "TAG" or "SEQUENTIAL" number for reproduction.

Memorizing time: Approx. 300 ms in average
Approx. 600 ms in maximum

Multiple media memorizing:

● **Master Unit Stand-alone system**

In the continuous memorizing mode, when a medium has been memorized, the Master Unit displays "999" for the "SEQUENTIAL" number, requesting the next medium after ring the buzzer. The **-TR-9305** Digital Spectrum Analyzer automatically starts data collection after media have changed without suspending measurement. The "SEQUENTIAL" number restarts at "0".

● **Master Unit plus one or more Slave Units system**

In the continuous memorizing mode, when a medium has been memorized, data collection is automatically transferred to a floppy disk unit which is set at that time. The transfer time is almost zero. The "SEQUENTIAL" number restarts at "0" for media, however, it will be recognized at a serial number in display and search.

Fig. 14

FREQ.	SENS.	TRIG. MODE	AVG MODE	RES./WGT	SCALING	SELECT	DISP.
◇TIME ◇ZERO START ◇INPUT AC ◇AUTO ARM ◇AVG 1024/1024 FREQ RANGE 100 KHz ⇨ 50 # 20 10 5 2 1 500 Hz 200 100 50 20 10 5 2 1 FRAME TIME 8 mSEC	◇AVG ◇ZERO START ◇INPUT AC ◇FREE RUN ◇AVG 128/128 SENSITIVITY ⇨ AUTO # (dBV) +30 +20 +10 # 0 -10 -20 -30 -40 -50 -60 MAX INPUT ±4.47 V _p	◇TIME ◇ZERO START ◇INPUT AC ◇ARM ◇AVG 469 TRIGGER POSITION 1/1 ⇨ 1/2 # 1/4 1/8 0 LEVEL +3/4 +1/2 +1/4 # 0 -1/4 -1/2 -3/4 SLOPE <-> # <+> SOURCE INT # EXT SAMP CLOCK INT # EXT	◇INST SPECT ◇ZERO START ◇INPUT AC ◇FREE RUN ◇AVG 0 AVG MODE SUM ⇨ PEAK # DIFF EXP TIME HIST AVG NUMBER 1 2 4 8 16 32 64 # 128 256 512 1024	◇INST SPECT ◇ZERO START ◇INPUT DC ◇FREE RUN ◇AVG 0 RESOLUTION ⇨ NORMAL # 1/3 OCT 1/1 OCT WEIGHTING RECT HANN # READ OUT FREQ UNIT Hz # CPM VERT UNIT V ² V dBV # LIN VERT SCALE LINV ² # LINV	◇INST SPECT ◇ZERO START ◇INPUT DC ◇FREE RUN ◇AVG 0 OVERALL ⇨ OFF ON # SCALING OFF ON # 0dB _{EU} = +123.4 dBV I/O SELECT XY-REC PLOTTER # F DISK PLOTTER MODE 1 ⇨ MODE 2 # MODE 3	◇INST SPECT ◇ZERO START ◇INPUT DC ◇FREE RUN ◇AVG 0 FREQ RANGE 5 KHz SENSITIVITY 0 dBV TRIGGER POSITION 0 LEVEL 0 SLOPE <-> SOURCE INT SAMP CLOCK INT RESOLUTION NORMAL WEIGHTING HANN AVG MODE SUM AVG NUMBER 1	

Fig. 15 -TR-9305 Digital Spectrum Analyzer optional "menu"

Built-in three basic signal analyzing capabilities

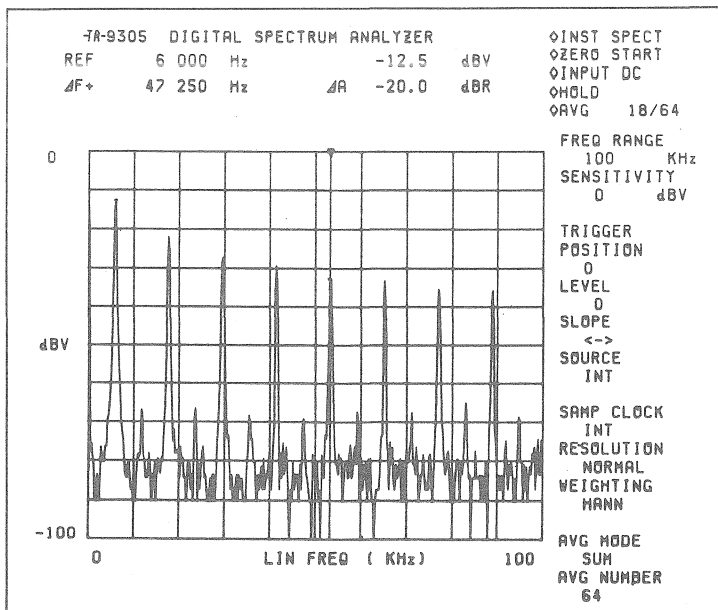

Measurement in frequency-domain:

The spectrum analyzer analyzes a spectrum over a frequency range of 2.5 MHz to 100 kHz and a resolution of 400 lines for each range. Real-time analysis is possible up to the 2 kHz range.

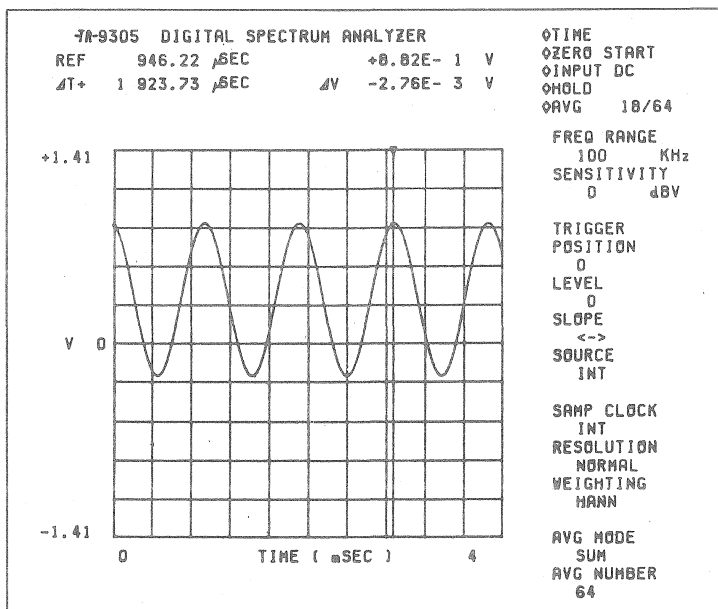

Measurement in time-domain:

The instrument can be used as an oscilloscope or a transient memory scope with a time response from an ultralow frequency up to 100 kHz. Any waveform which is difficult to synchronize can be caught easily.

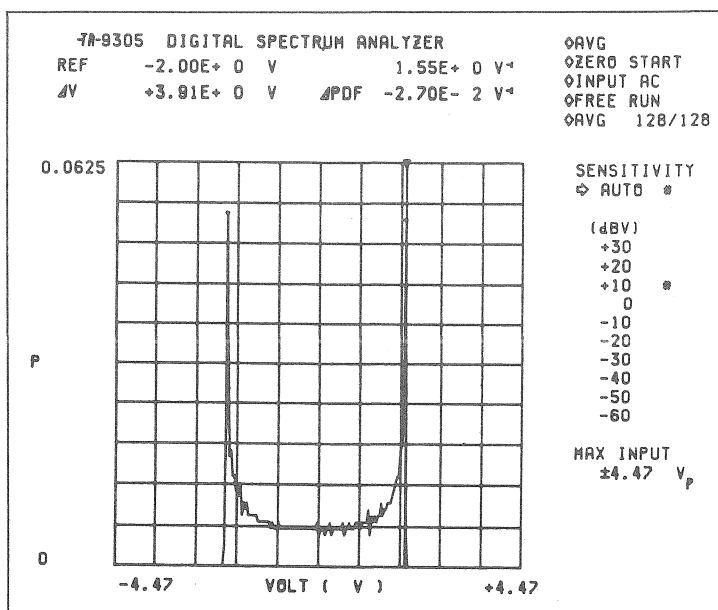

Measurement in amplitude-domain:

The instrument can be used as a histogram meter. Histogram observation of a waveform with noise or a waveform with much drift provides easy understanding of the mean value, maximum value, minimum value, and the properties of the waveform.

New Analysis by Dual Display

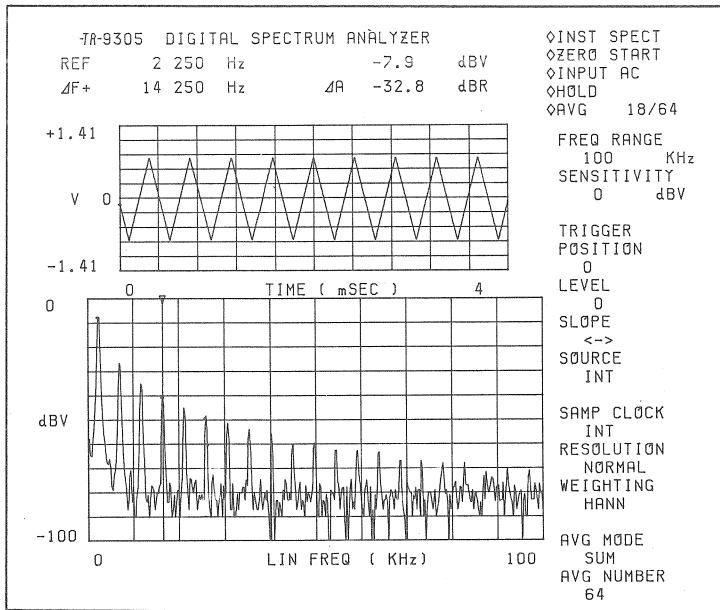

Display in time- and frequency-domains:
 The waveform and frequency spectrum of a triangular wave can be understood at a glance.

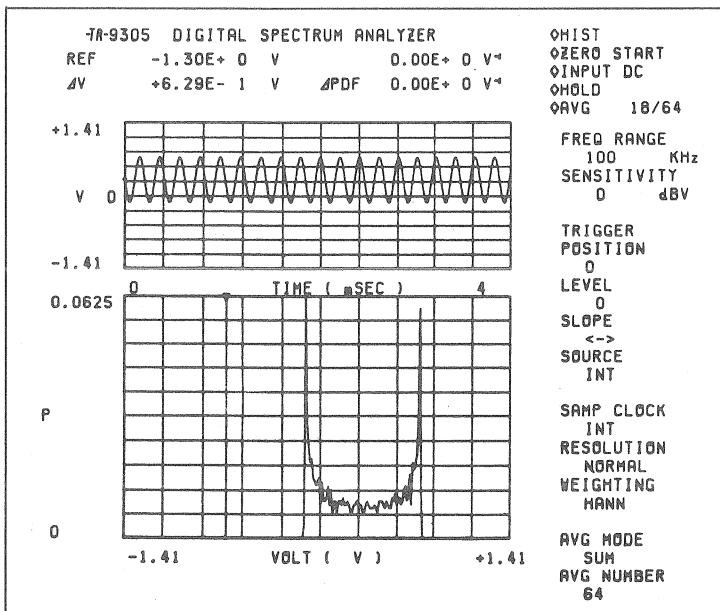

Display in time- and amplitude-domains:
 The waveform and amplitude distribution of a sinusoidal wave can be observed simultaneously. The offset value can be observed more conveniently in the amplitude domain rather than in the time domain.

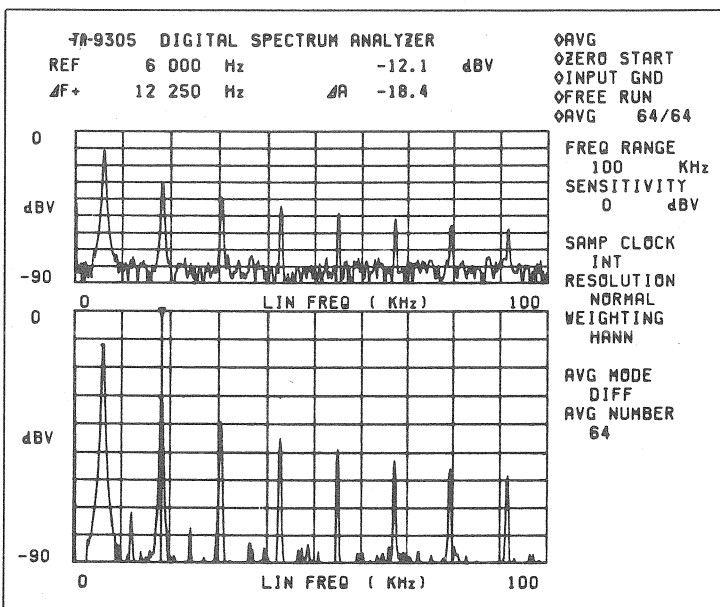

Real-time spectra and averaging in the frequency domain:
 The upper recording shows a real-time spectrum, and the lower one shows the result of averaging by 64 times with the noise component subtracted.

Zooming function for analysis of neighbouring spectrum

With its 201-point resolution, a spectrum of up to 100 kHz can be magnified by 2 to 128 times. The center frequency can be moved horizontally by key operation. This function is provided as standard.

Spectrum analysis of "wow" and "flutter" test signals:

A single peak may be observed in a 3 kHz test signal when it is analyzed in the 5kHz range in the "0"-start mode.

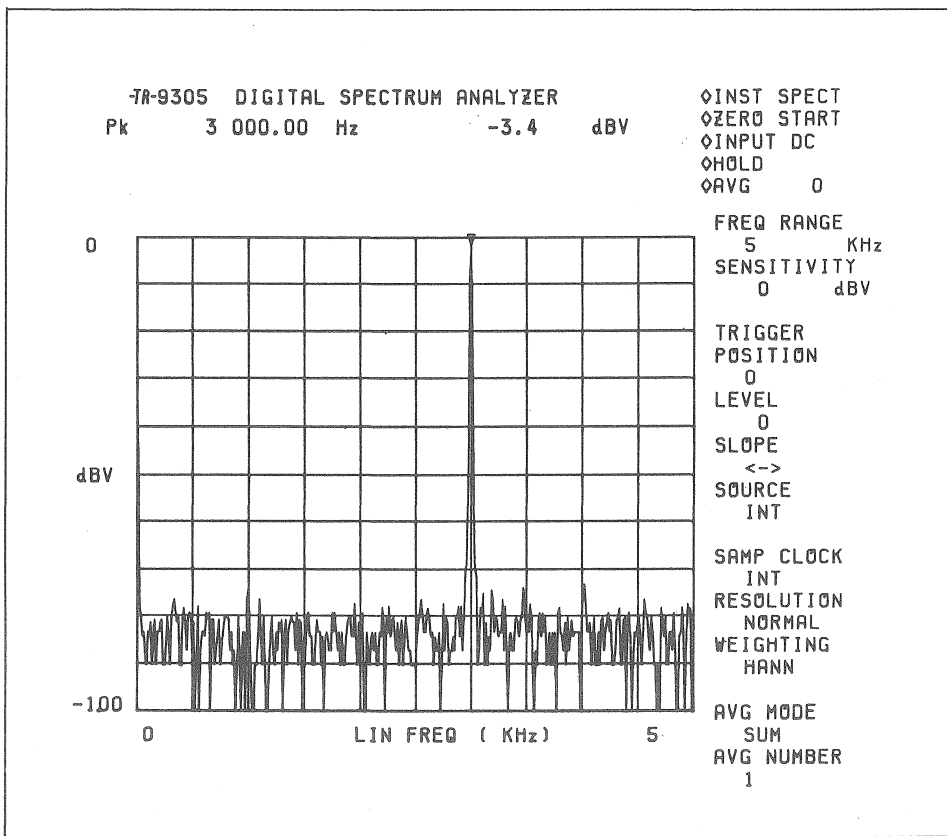

When the above signal is zoomed by 128 times with the center frequency at 3 kHz in the 5 kHz range, wow and flutter caused by the capstan and pinch roller are as shown here.

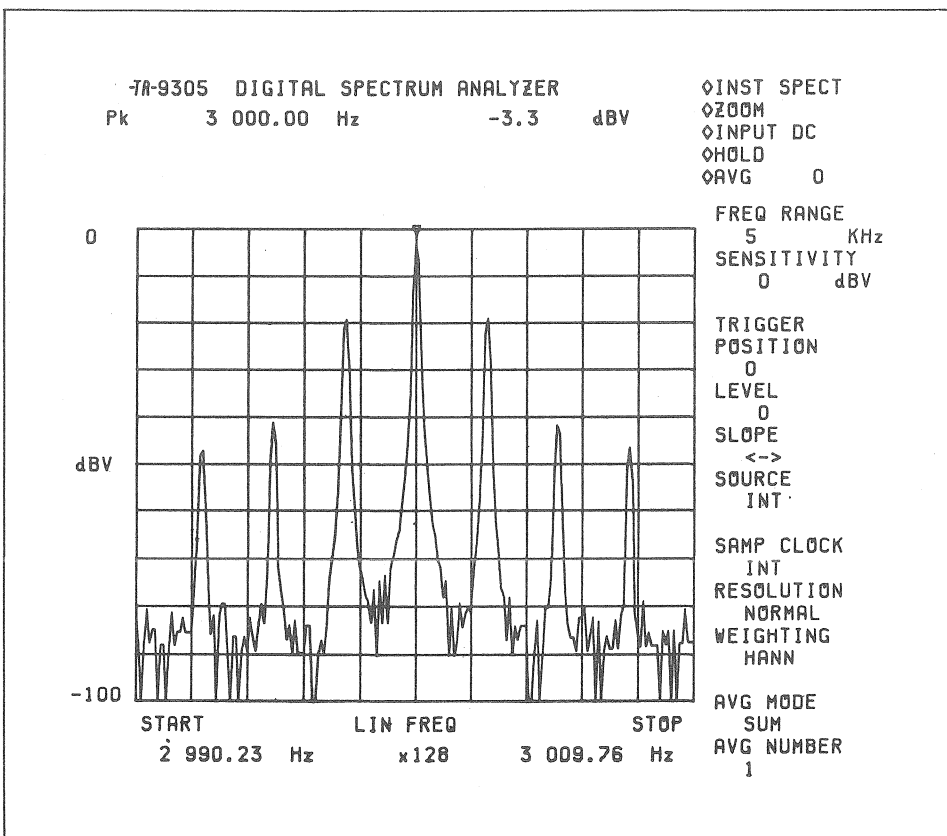

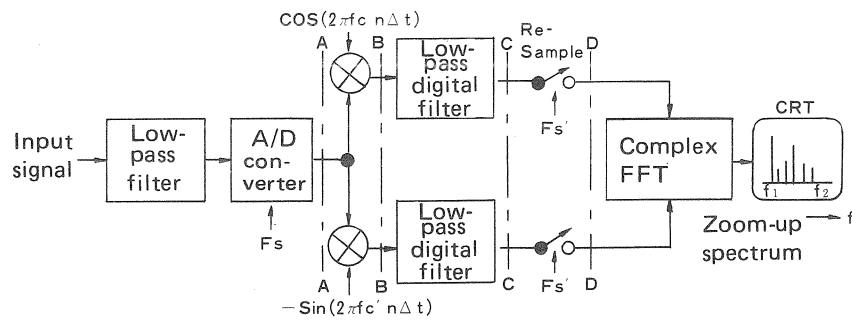

Frequency domain Indicates a peak to be magnified.

A-A:
After low-pass filter
and A/D converter

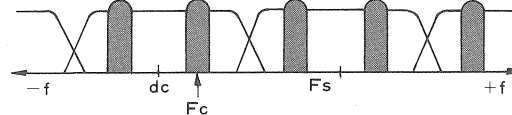

$$\Delta f = F's / N = F_s / n \cdot N = 1 / T'$$

B-B:
After spectrum is
shifted by fc

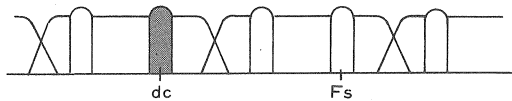

- F's: Re-sampling frequency
- N: Number of lines of a frequency spectrum
- Fs: Original sampling frequency
- n: Magnification factor
- T: Framing time (Time-domain recording time interval)

C-C:
After passing
the digital filter

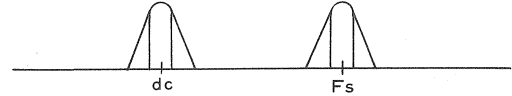

D-D:
After passing
the re-sampling switch



Conceptual diagram of digital zooming

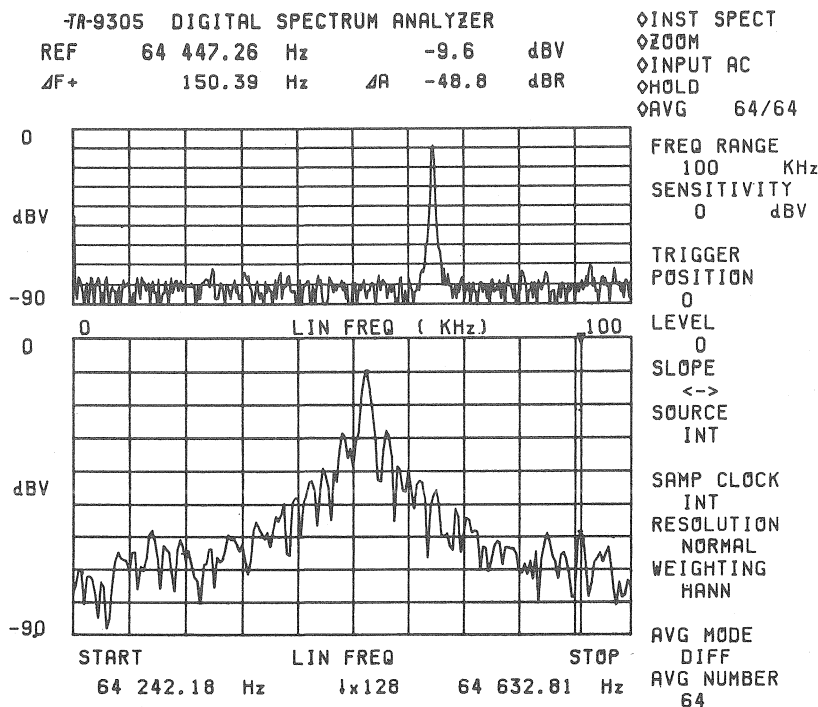

Zooming function is valid up to 100 kHz:

The upper example is the display of a 64 kHz signal observed in "0" start mode, and the lower one shows the zoom-up peak magnified by 128 times in dual display. In the zooming operation, the start and stop frequencies within the measurement range are also displayed.

High-sensitivity, wide dynamic range and wide-band

Amplitude from +30 dBV to -120 dBV (-160 dBV in display) can be measured in steps of 10 dB in the 100 kHz band. Also automatic range switching (AUTO-RANGE) is possible.

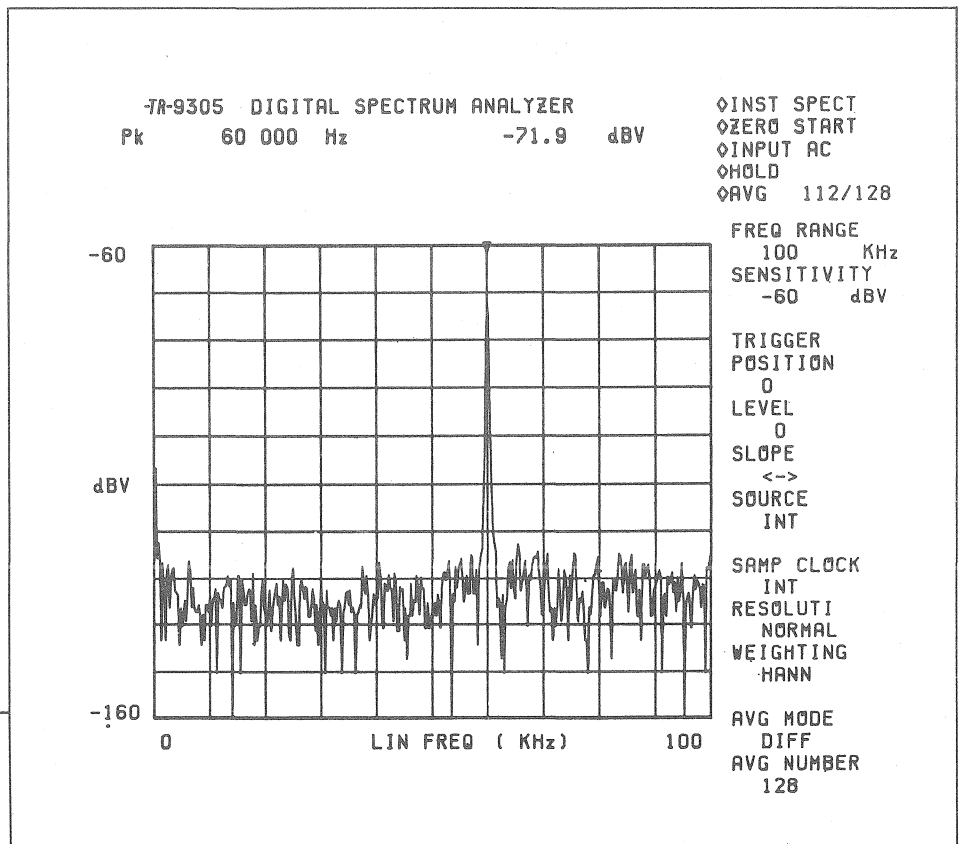
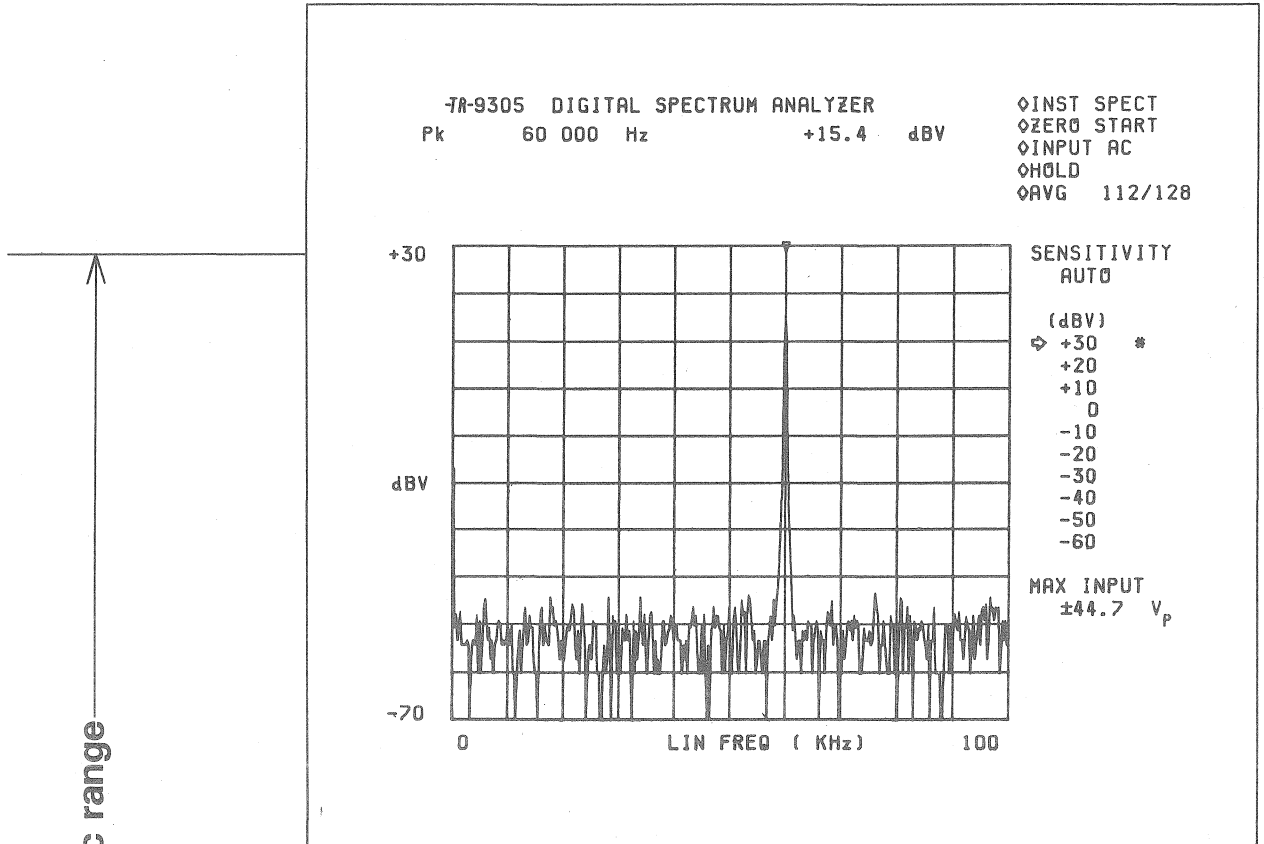

Display mode

The display dynamic range can be varied from 60 dB to 100 dB.

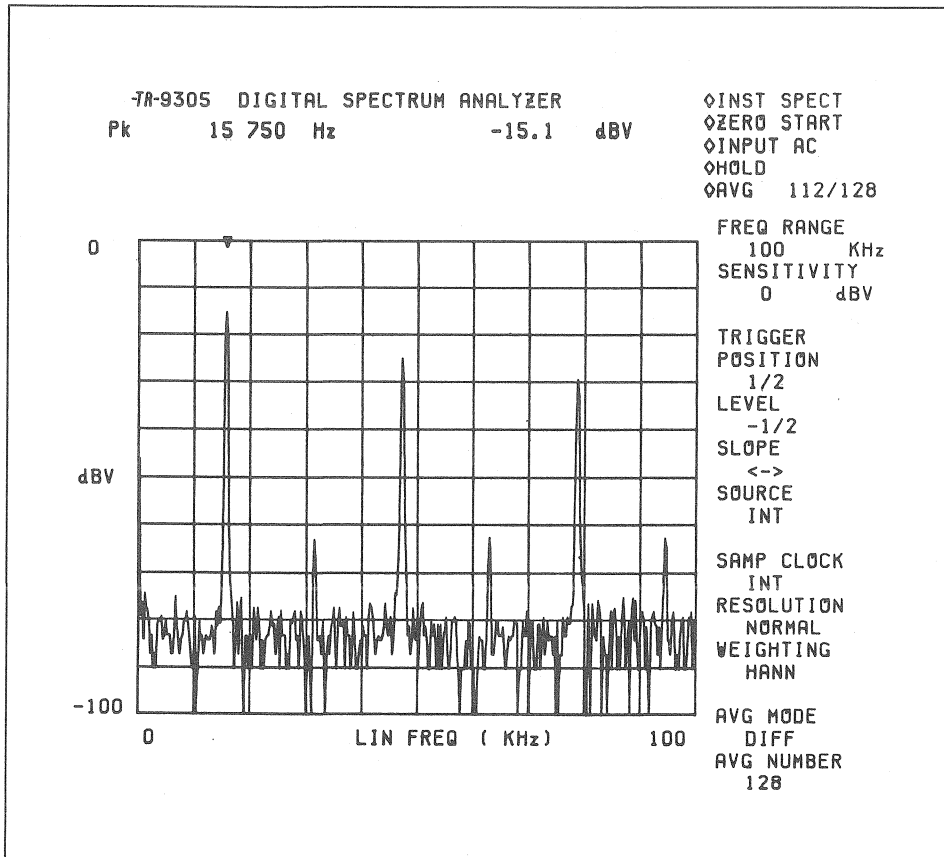
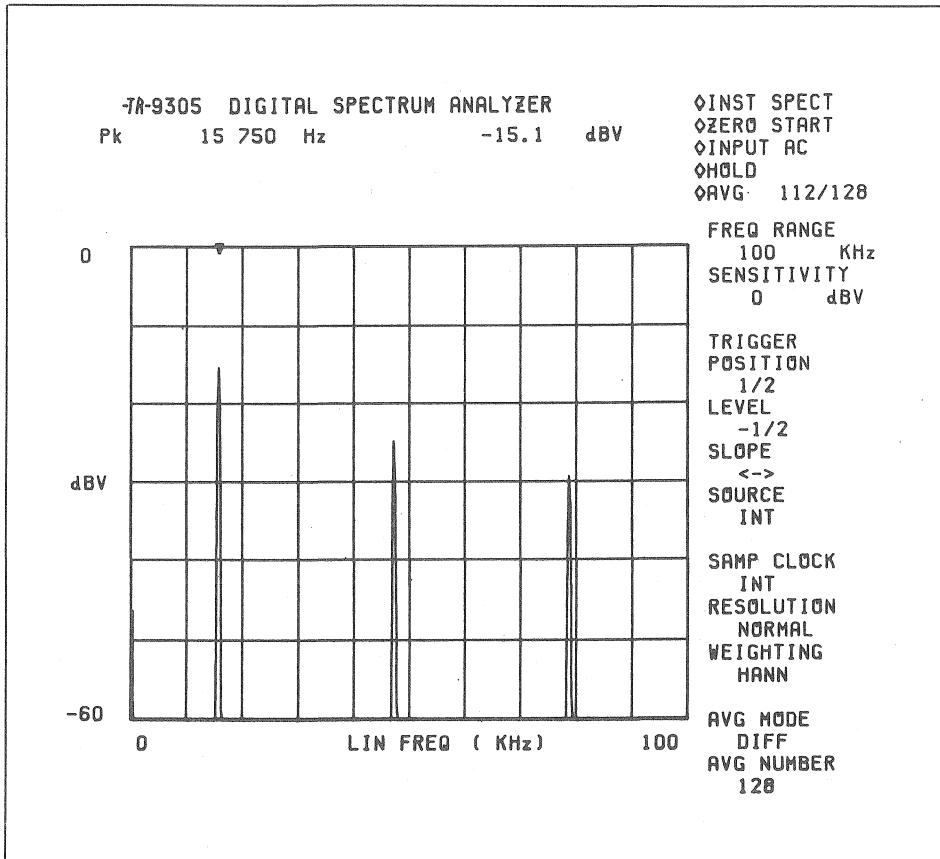

Even higher harmonics cannot be observed in the 60 dB display dynamic range.

In the 100 dB display dynamic range, not only even higher harmonics but also the noise level can be observed up to the limit.

Display mode

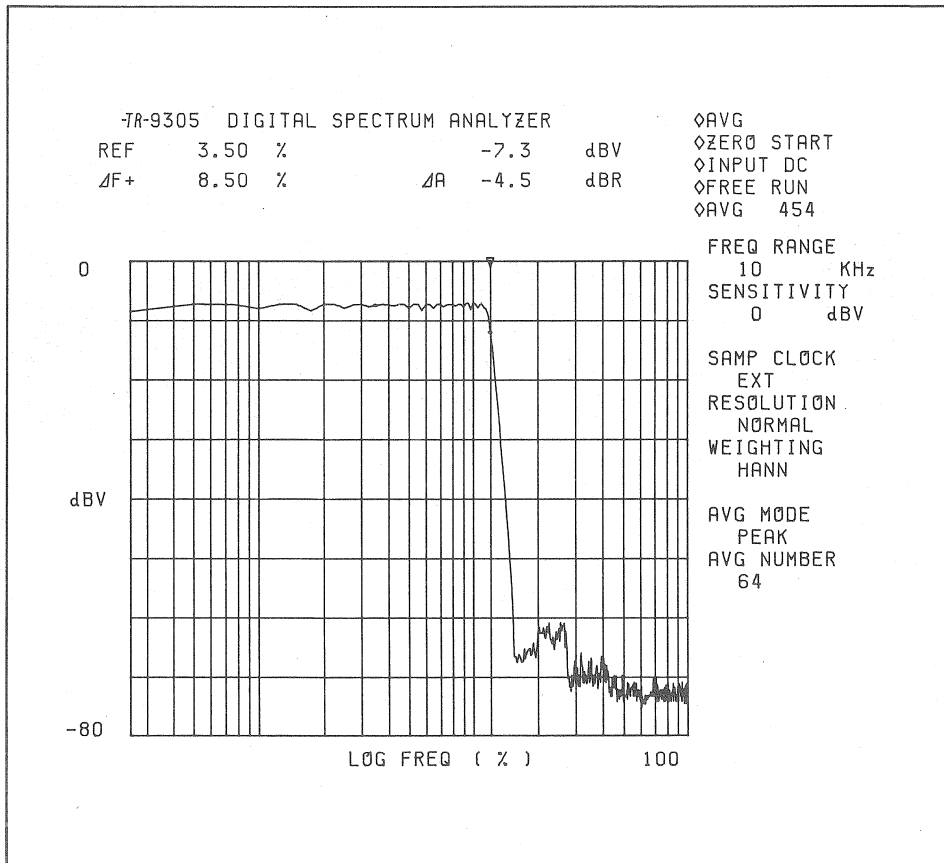

The frequency can be plotted on the logarithmic scale.

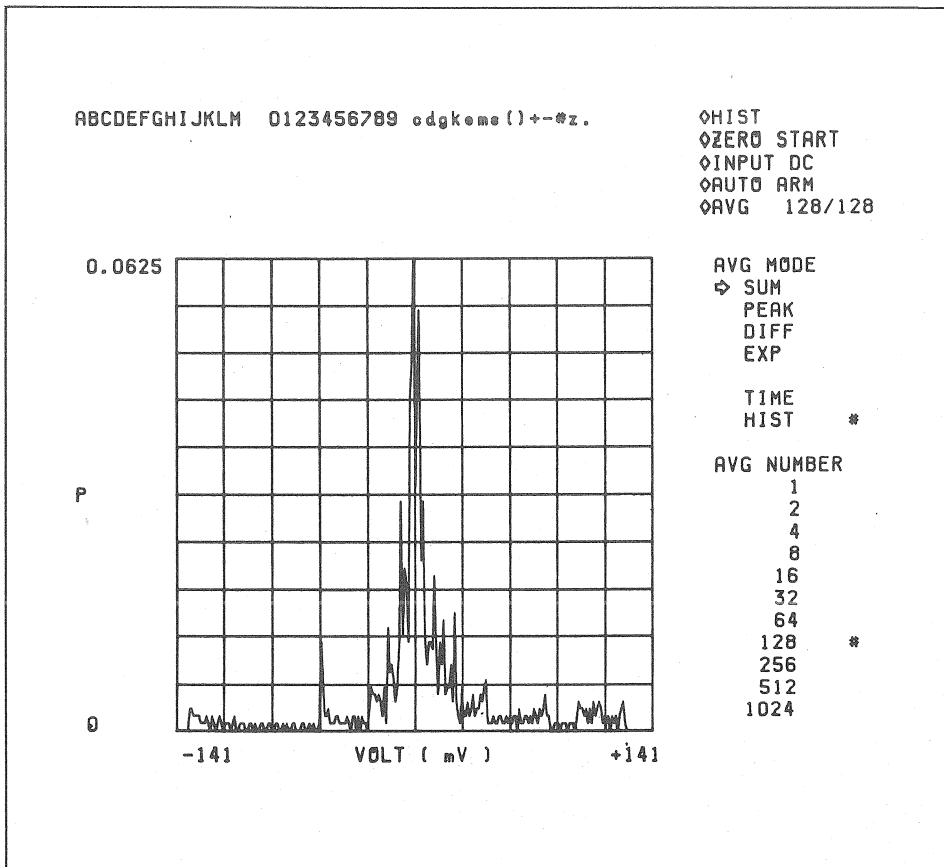

Label mode:

Up to 40 alphabetical characters, numerical characters and unit symbols indicated on the front panel switches can be displayed in the uppermost stage of the CRT screen.

Display mode

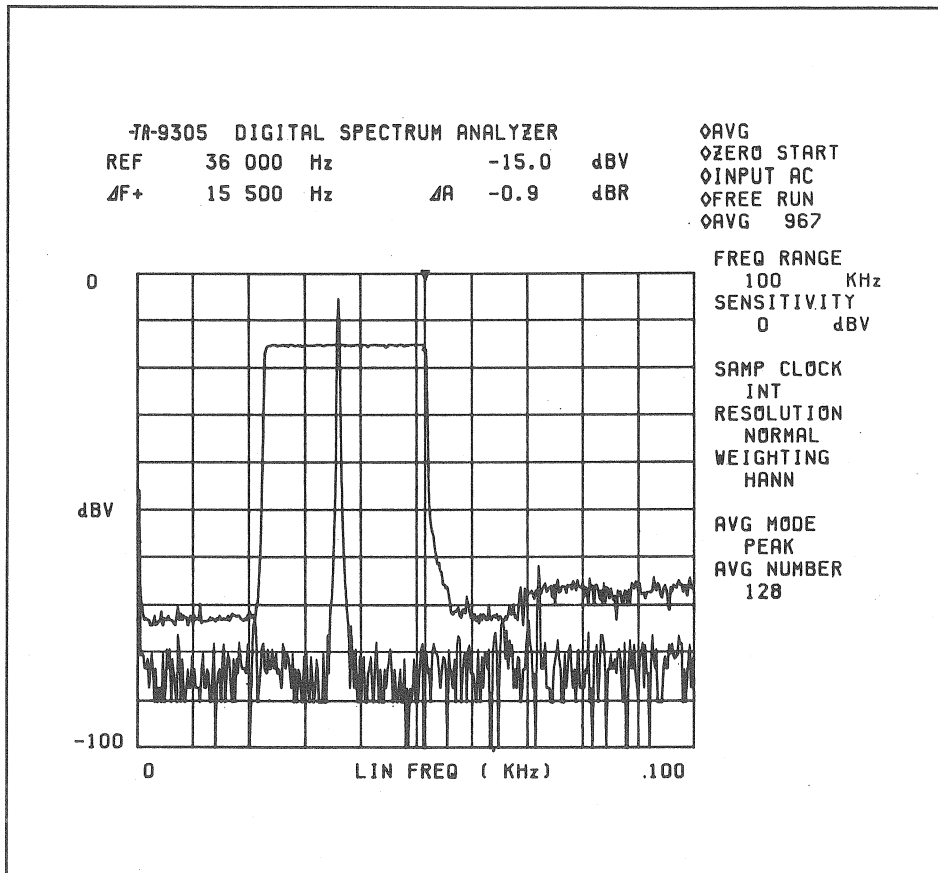

Overlapped display mode:

If the measurement conditions are the same in the frequency-domain data, two data can be displayed one on the other.

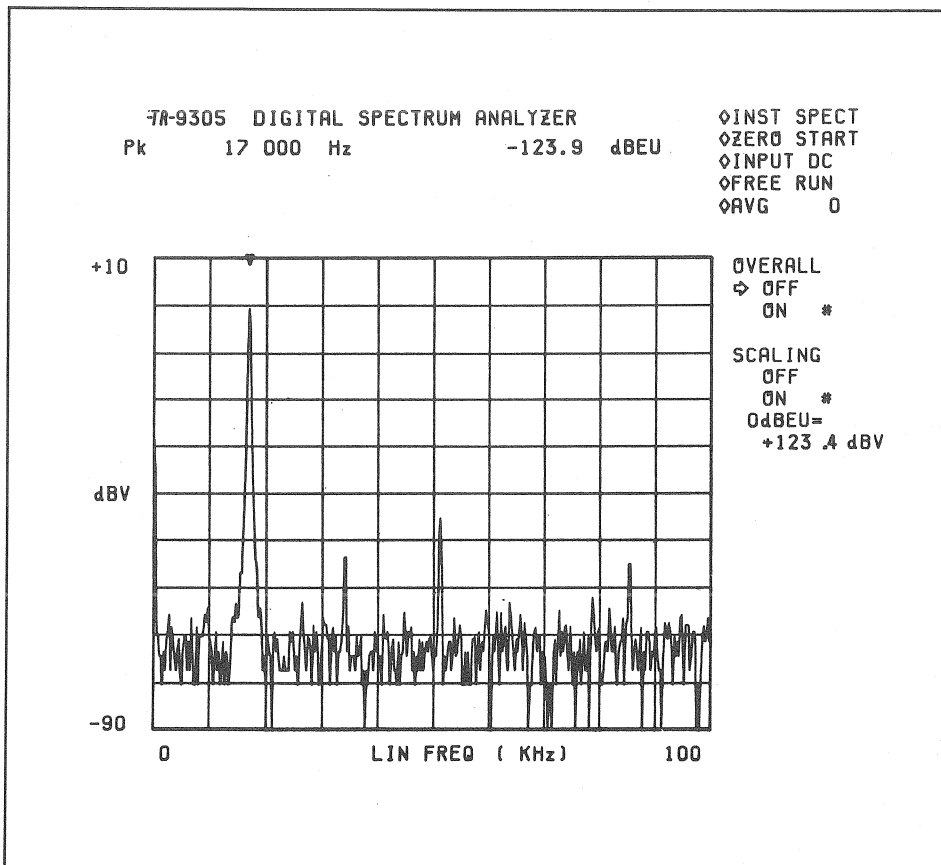

Direct reading in industrial units

Units of V and V^2 based on 1 V RMS and normalized unit of dBEU based on 1 V = 0 dBV can be read directly.

Display mode

The amplitude of the frequency domain data can be displayed on either the logarithmic or linear scale.

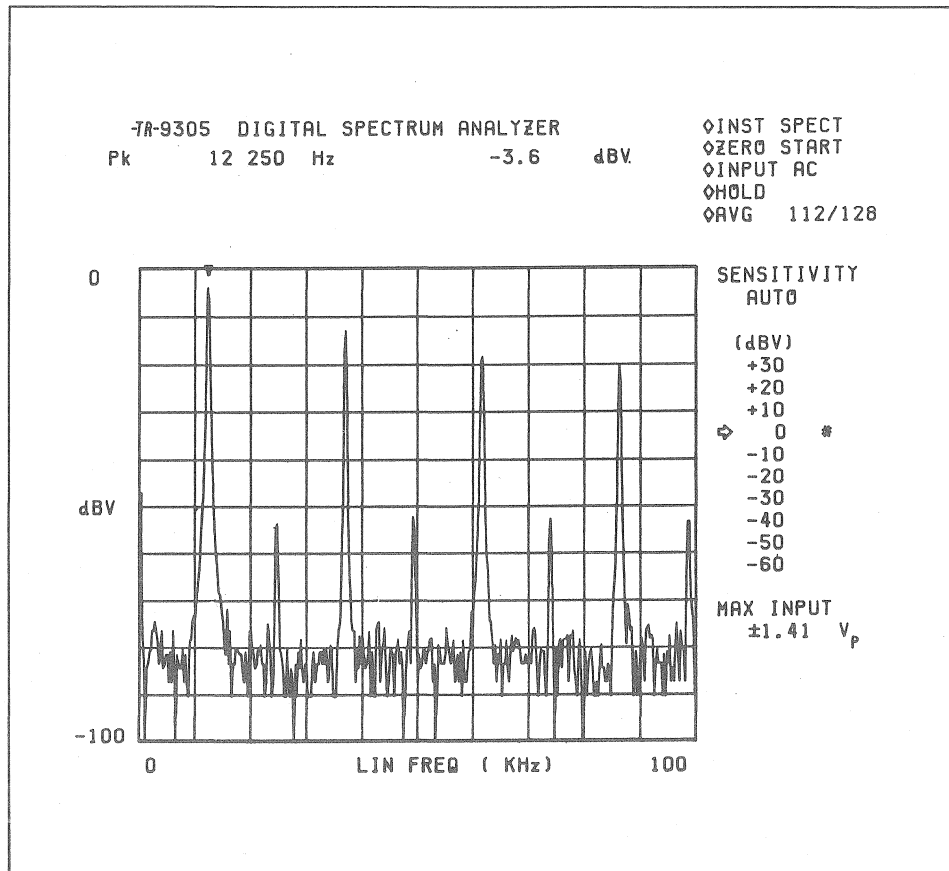

Data is displayed on the logarithmic scale in a dynamic range of 100 dB at 10 dB/div.

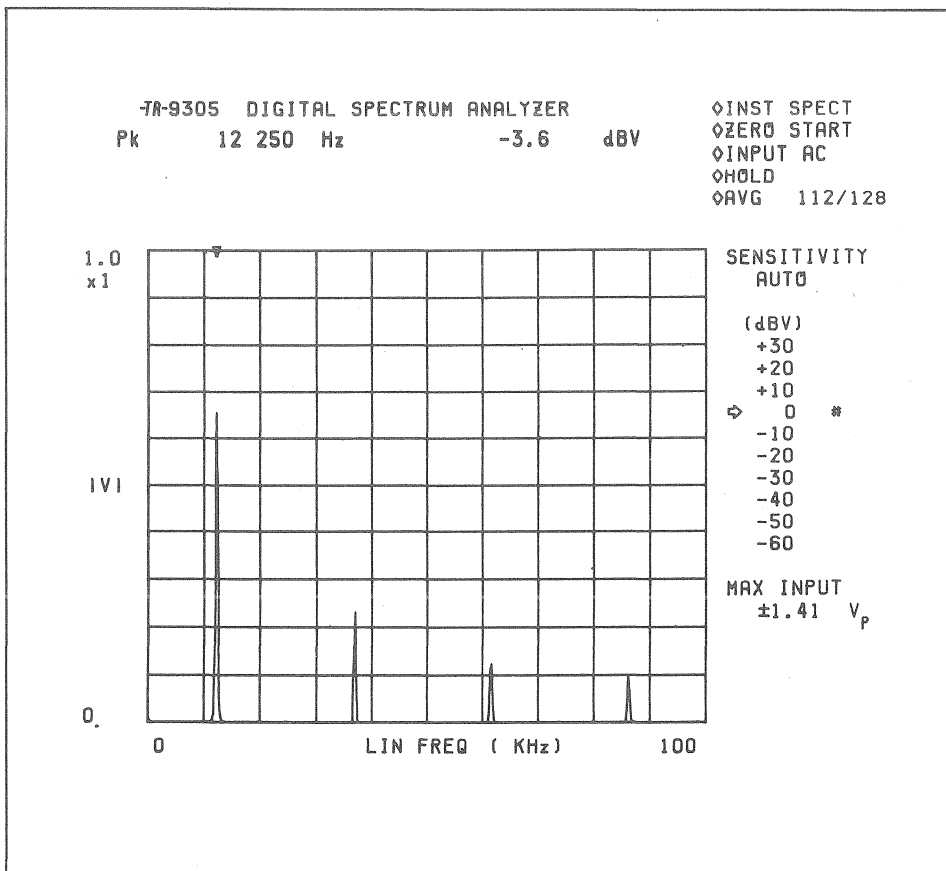

The above data is displayed on the linear scale.

Display mode

The harmonic mode, linear mode and total harmonic distortion (THD) are computed simultaneously.

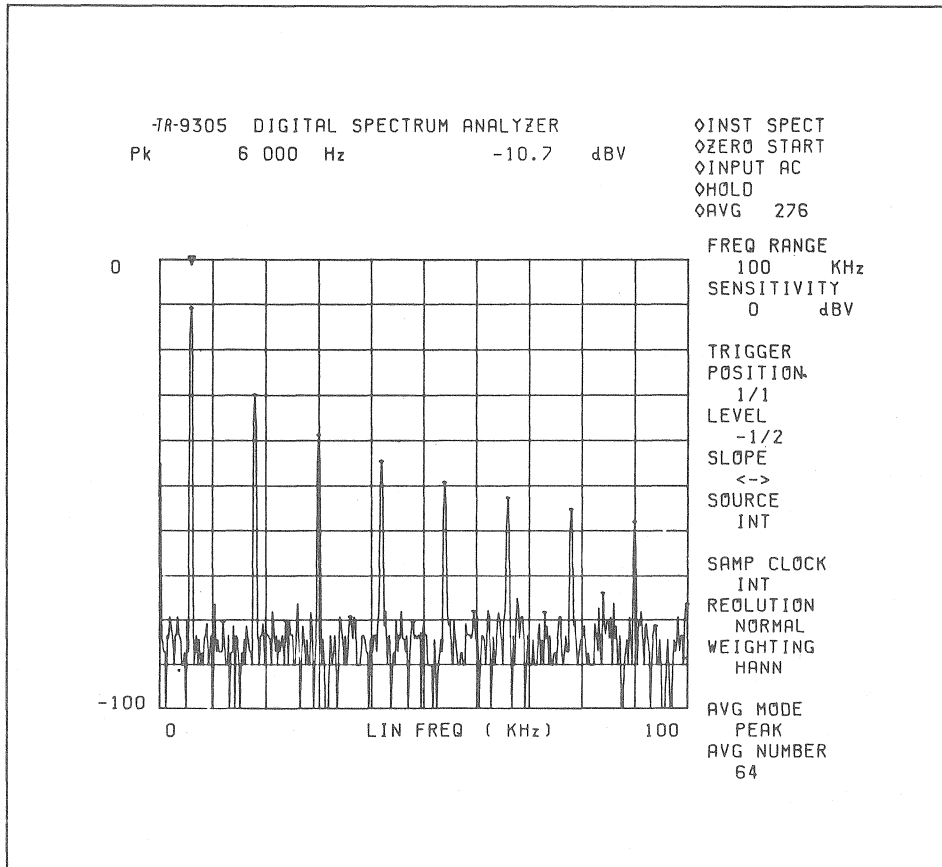

The maximum spectrum (fundamental wave) is automatically searched and the higher harmonics are marked. It can be seen that even higher harmonics are marked even at a low level.

7A-9305 DIGITAL SPECTRUM ANALYZER

Fundamental	6 000	Hz	-10.7	dBV		
Harmonics	2	12 000	Hz	-69.5	dBV	0.033 %
	3	18 000		-19.0		11.083
	4	24 000		-69.5		0.033
	5	30 000		-27.9		3.991
	6	36 000		-68.4		0.037
	7	42 000		-33.8		2.038
	8	48 000		-69.5		0.033
	9	54 000		-38.3		1.202
	10	59 500		-67.2		0.043
	11	66 000		-41.9		0.799
	12	73 000		-67.5		0.041
	13	78 000		-44.4		0.599
	14	84 000		-63.0		0.070
	15	90 000		-47.1		0.437
	16	94 000		-70.5		0.029
	17	100 000		-65.5		0.052
Total Harmonic	rms	:H	-29.0	dBV		
Total Harmonic	Distortion		12.084	%		

The fundamental wave and its higher harmonics are listed, with their level (relative value) to that of the fundamental wave, percent value and THD being computed automatically and displayed.

Automatic peak spectrum search mode and cursor mode

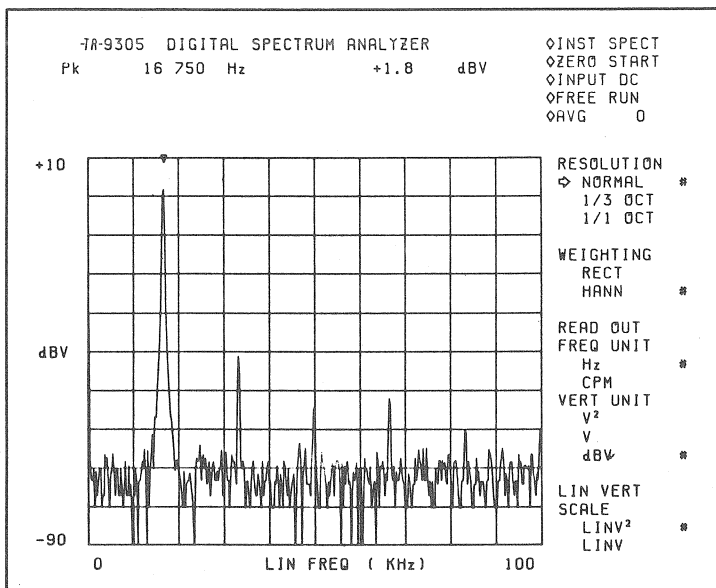

In the frequency-domain mode, when the cursor is turned off for both the real-time and averaging mode, the peak value of the displayed spectrum is automatically searched and its frequency and level are displayed on the screen. In the real-time spectrum analyzing mode, in which a spectrum varies, the peak is automatically tracked.

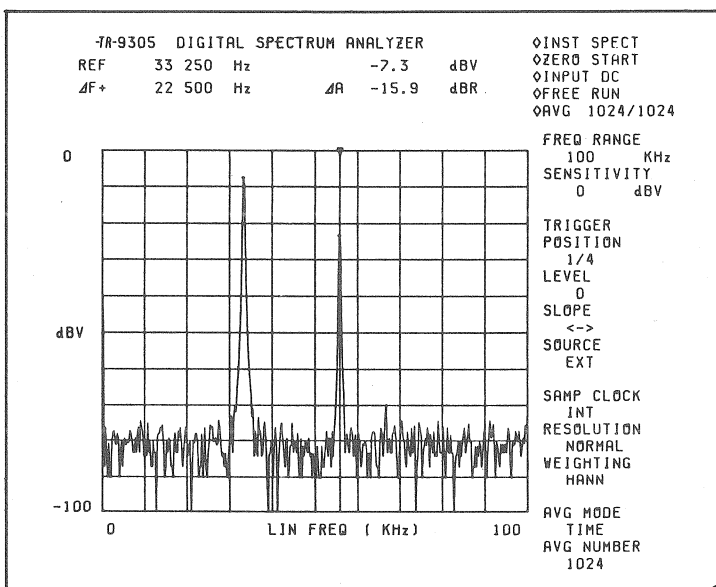

Various computations in the set-reference mode using cursor:

In the frequency domain, values of Δf and ΔdB for the portion are pointed by the cursor relative to those of the reference value. In the time domain, values of ΔT and ΔV are displayed together with the reference value.

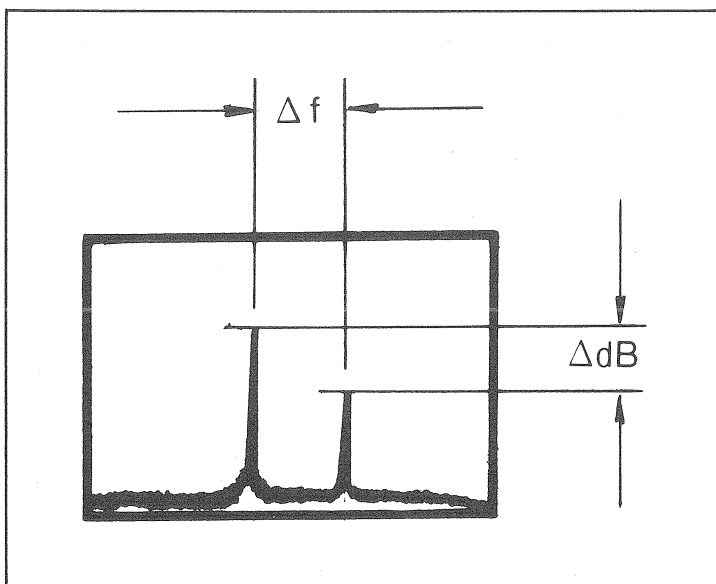

Automatic peak search mode and cursor mode

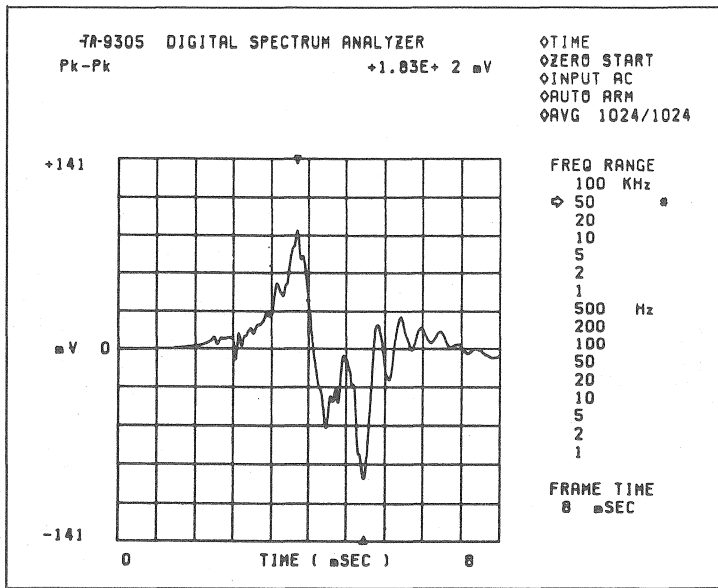

In the time-domain mode, when the cursor is turned off, the maximum and minimum values of currently displayed waveform are automatically searched and the peak-to-peak (Pk-Pk) value is displayed with a pair of marks "Δ" put on the time base.

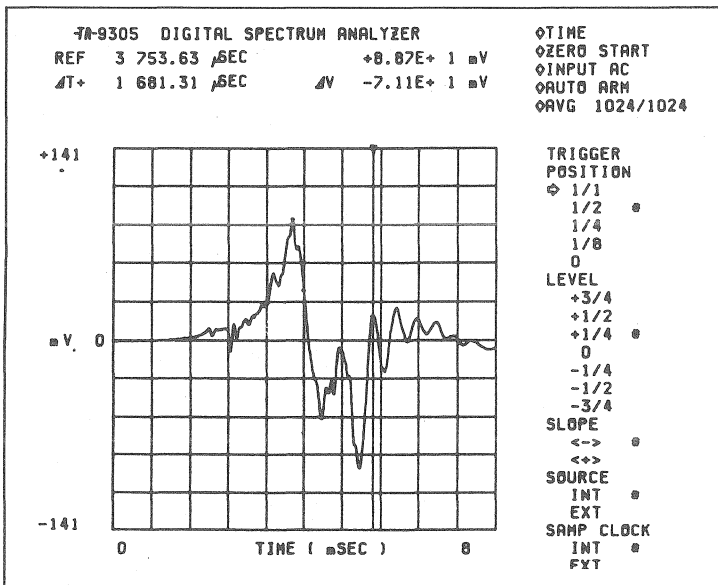

When the cursor is turned on in the time-domain mode, values of ΔT and ΔV of a measured point relative to an arbitrary reference point are displayed together with the absolute value of the reference point.

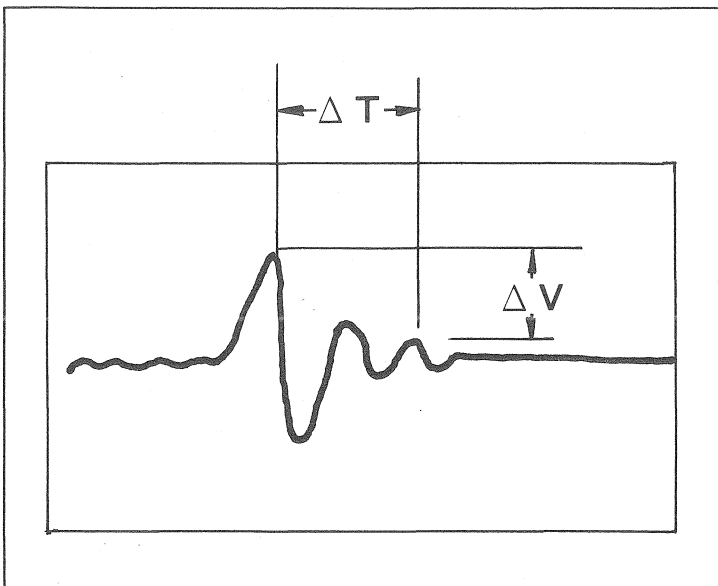

Transient data

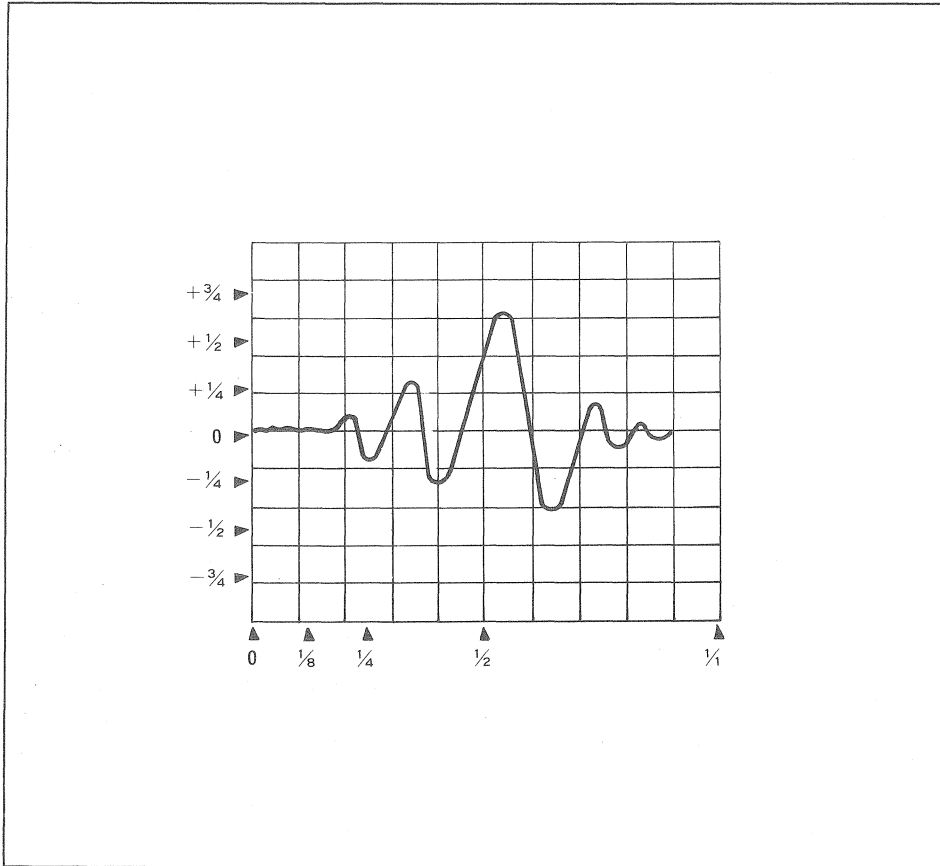

In catching transient data, the trigger position, trigger level and trigger slope can be set as shown in the figure. Internal or external triggering can also be selected.

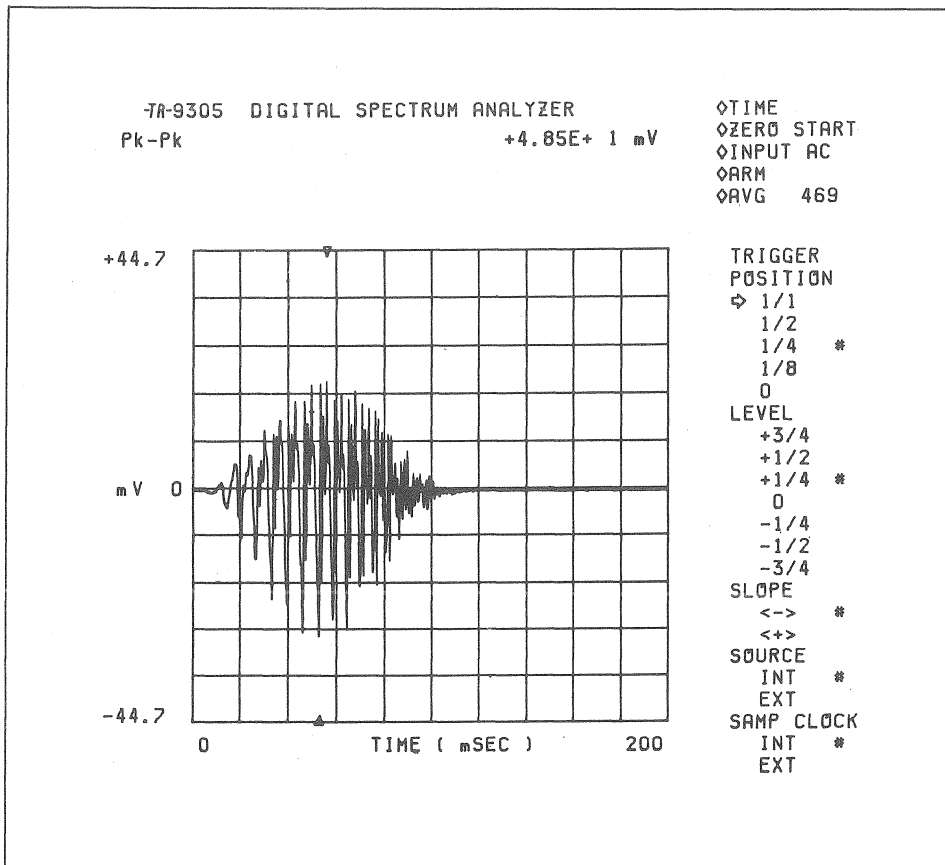

This waveform shows that of sound "ah" caught under the measuring condition displayed on the right.

Transient data

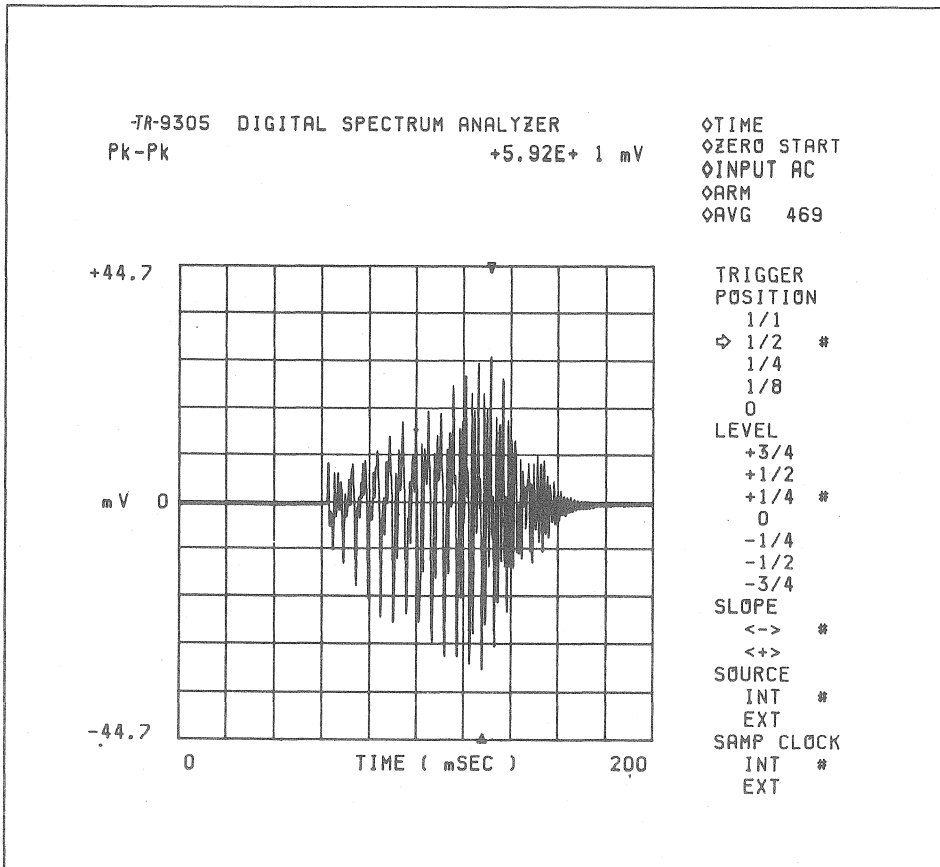

This waveform shows sound "ah" caught by setting the trigger position to 1/2.

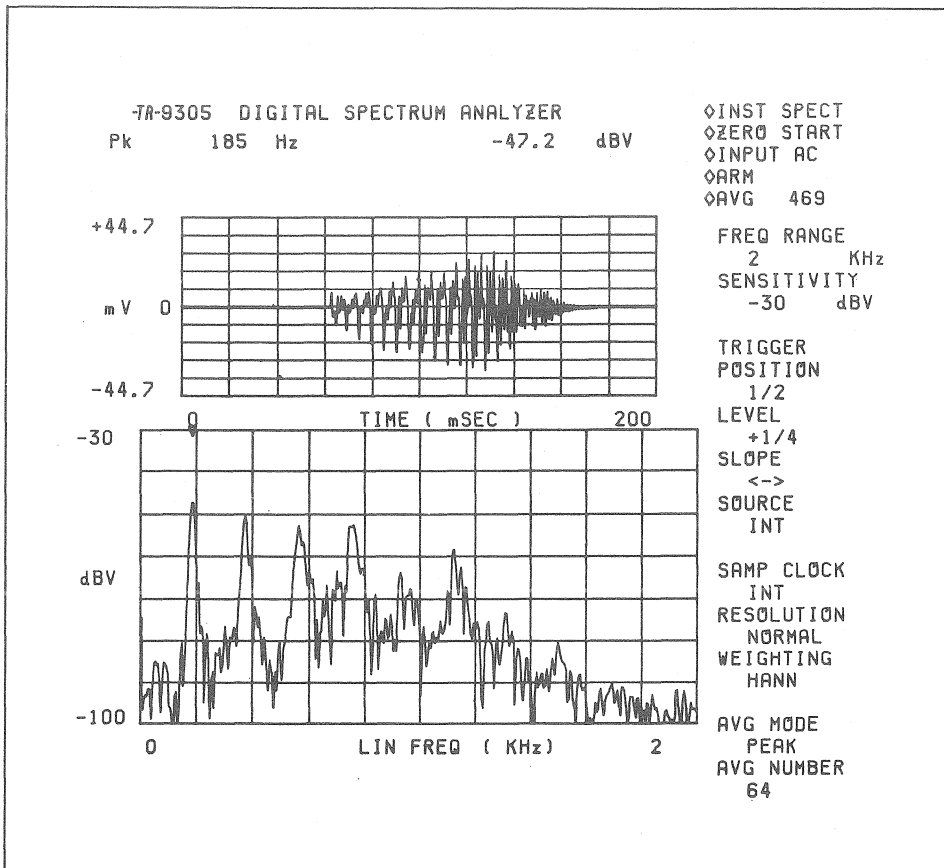

The above data is displayed in the time and frequency domains simultaneously.

Averaging mode

This instrument is not just an oscilloscope but also functions as a signal averager. The synchronization signal can be an input signal or an external pulse. The trigger position and level can be set freely.

This waveform shows the input signal of a triangular wave containing noise.

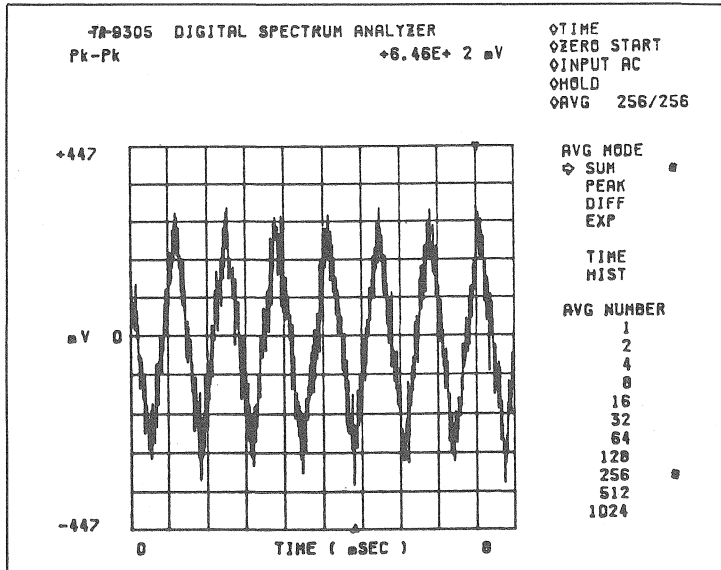

This display shows the result of spectrum averaging performed 256 times, indicating that the noise component has a flat spectrum up to the 50 kHz band.

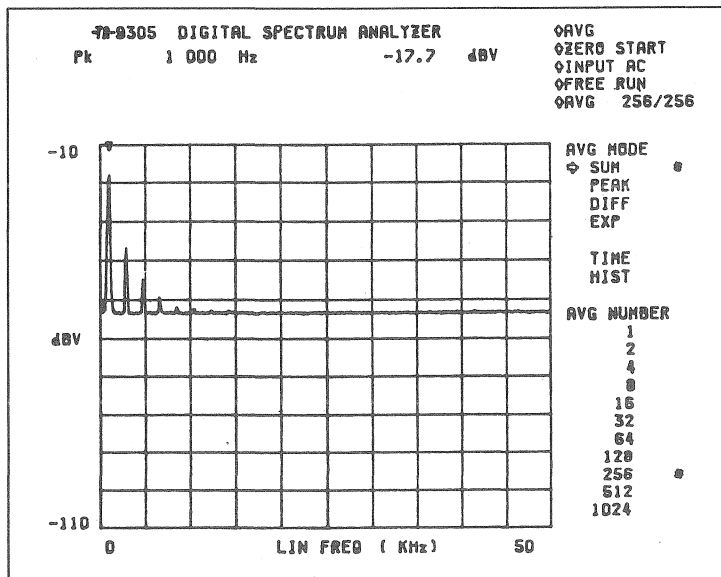

This display shows the result of time averaging performed 256 times in synchronization with the triangular wave, and its spectrum data. The spectrum shows reduced noise components that do not synchronize with the triangular wave, and higher order harmonics.

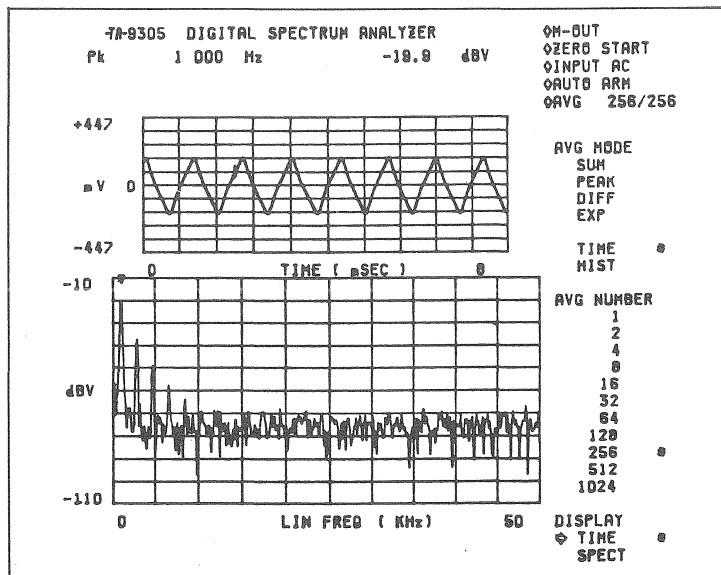

Averaging mode

Application of the time-averaging mode

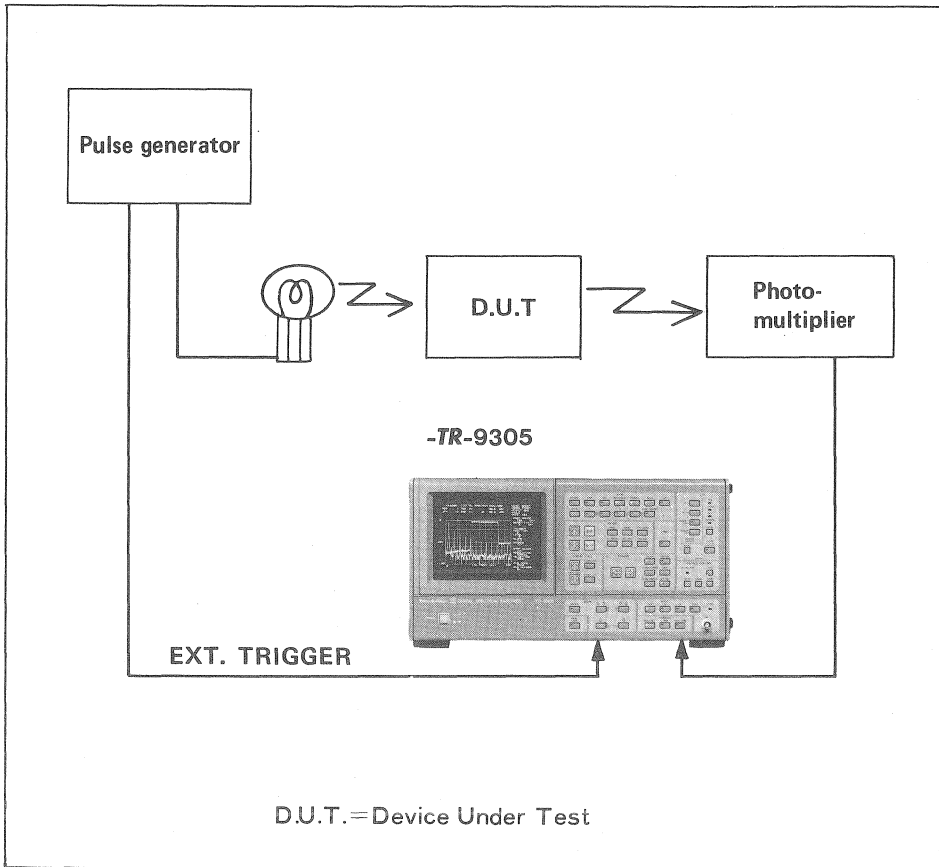

The signal caused by the reaction of a device under test is averaged in synchronization with the source signal from a pulse generator.

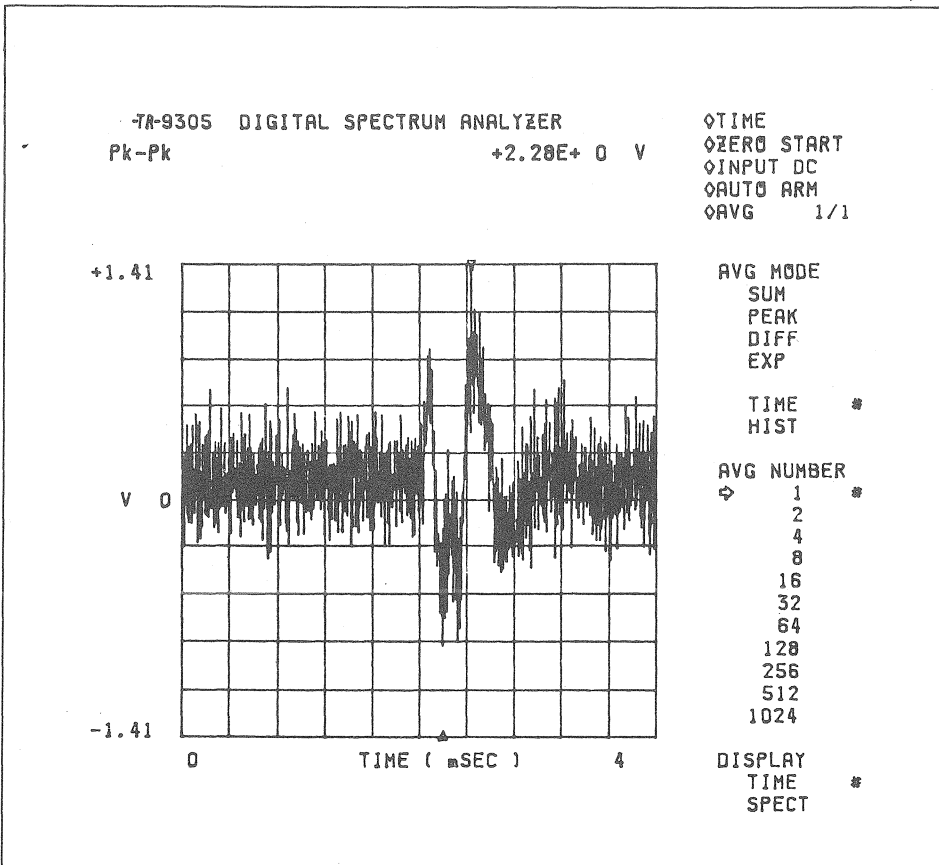

Output of the photomultiplier

Averaging mode

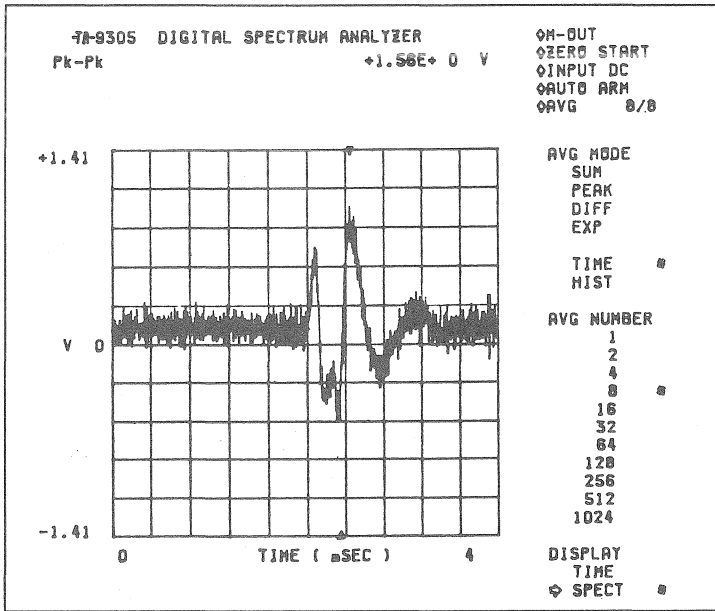

This is a waveform in the time domain after it has been time-averaged eight times. Signal components in synchronization with the external pulse are enhanced, while other components are reduced.

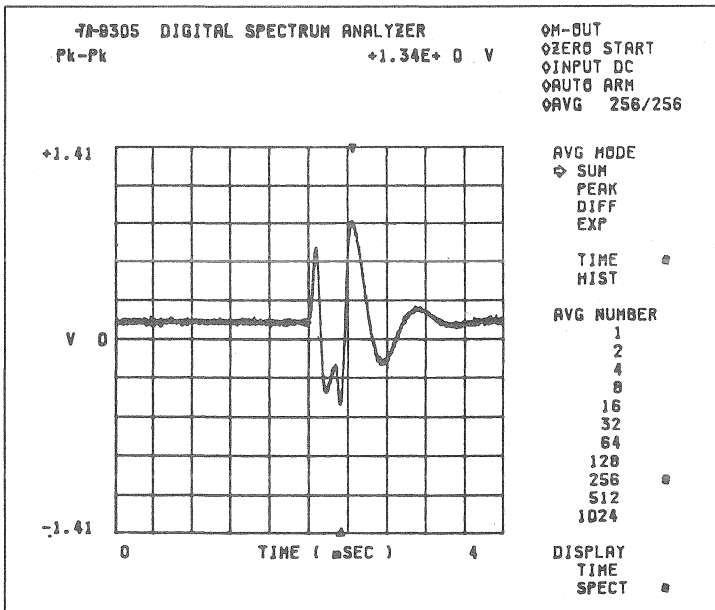

Result of 256 times of time-averaging

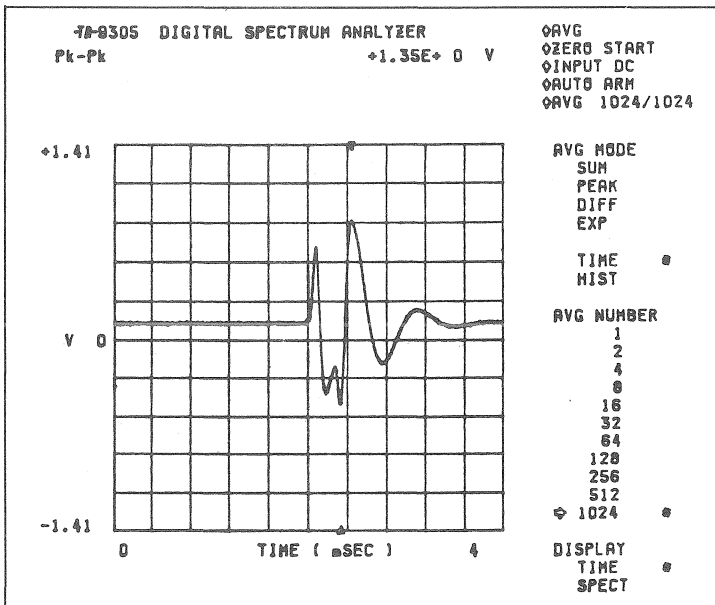

Result of 1024 times of time-averaging
Noise components are sufficiently reduced.

Averaging mode

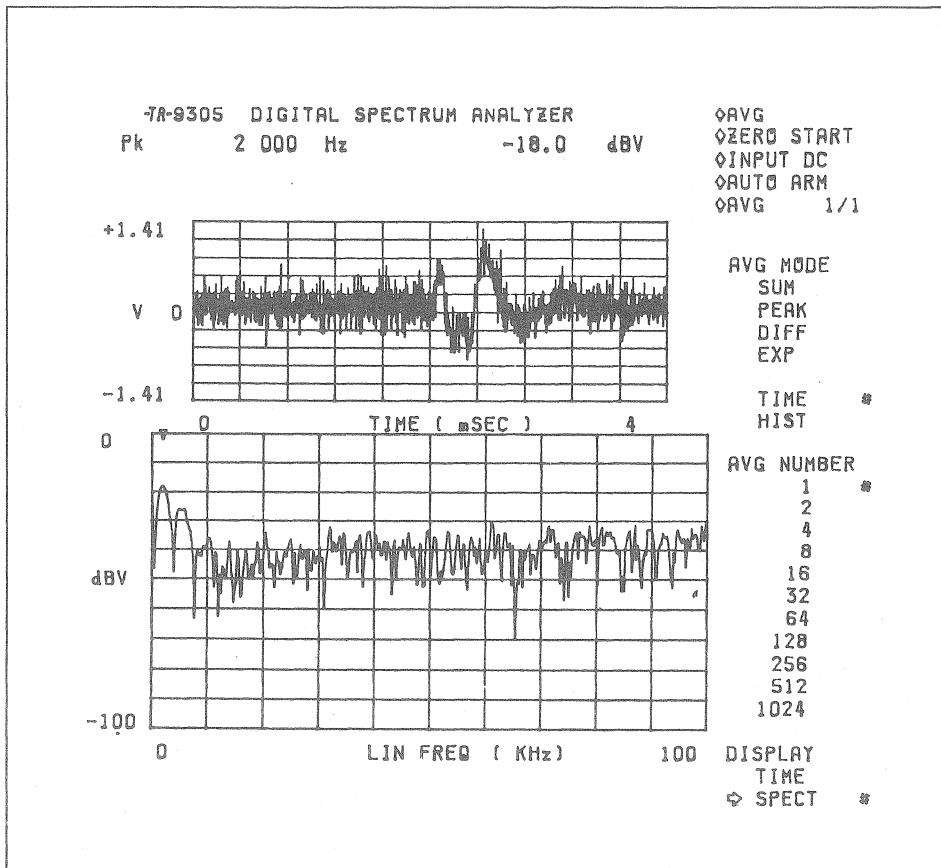

This display shows a waveform in the time domain and its spectrum without time-averaging.

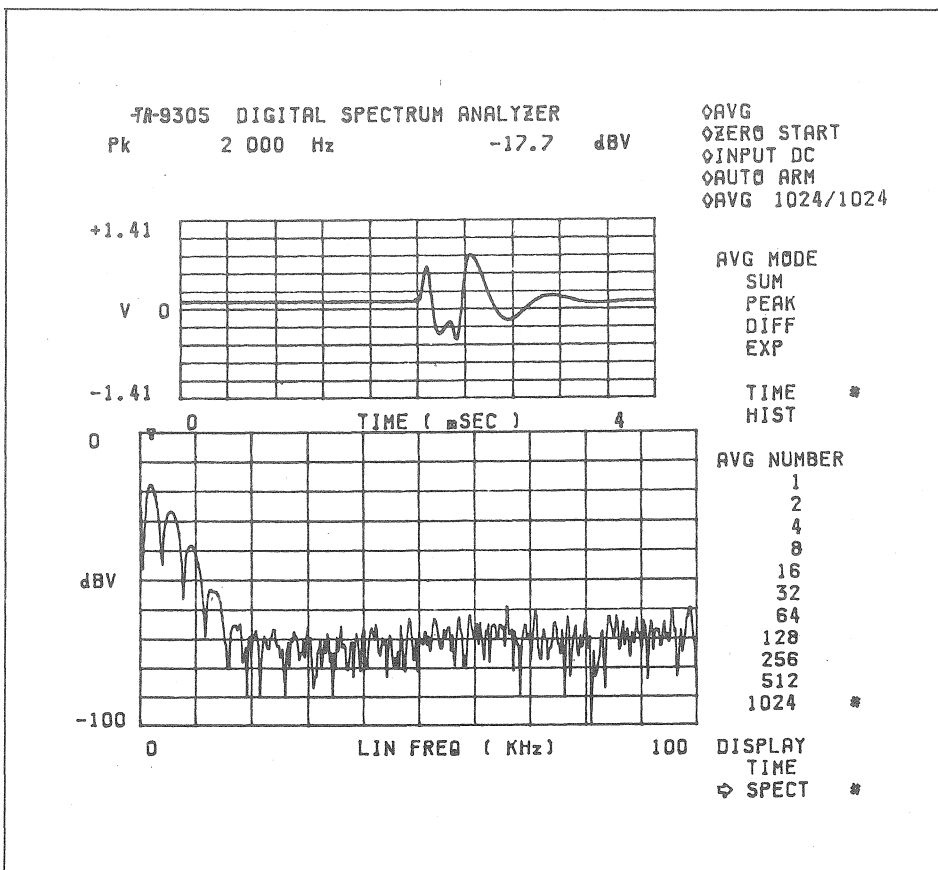

This display shows the above data in the time domain and its spectrum after it has been time-averaged 1024 times. It can be seen by comparing both spectra that the spectrum of noise components is eliminated and only the spectrum of the synchronized signal component is observed.

Averaging mode

Frequency response measured in the peak-averaging mode:

Before start

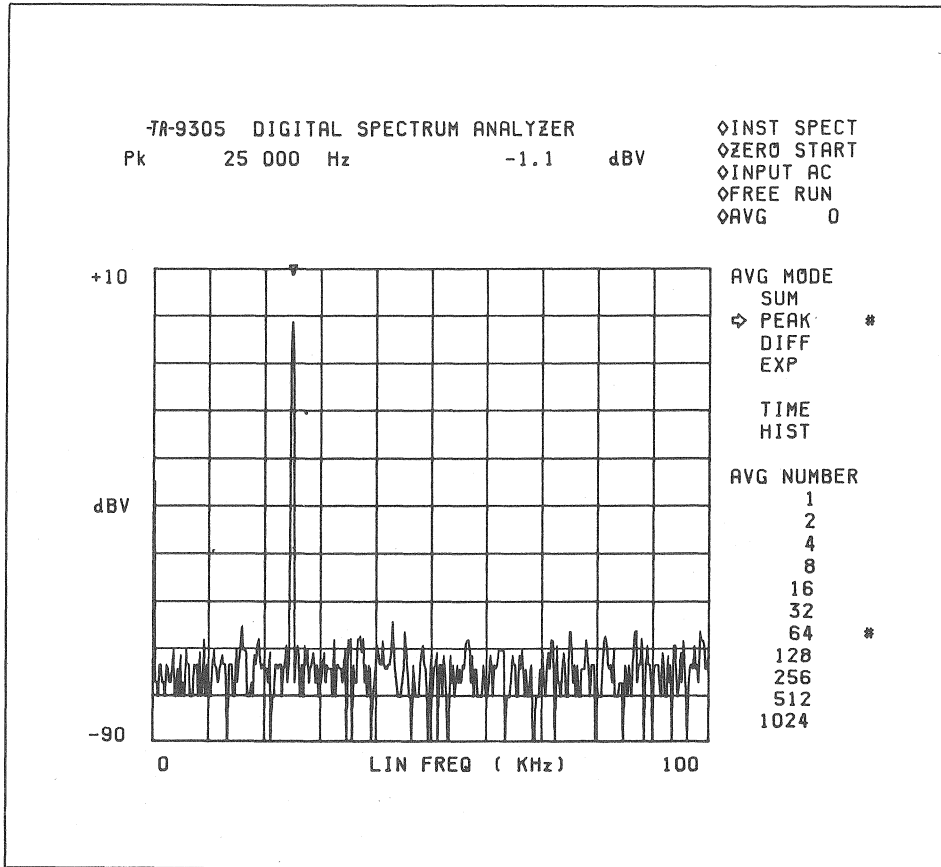

Result of peak hold

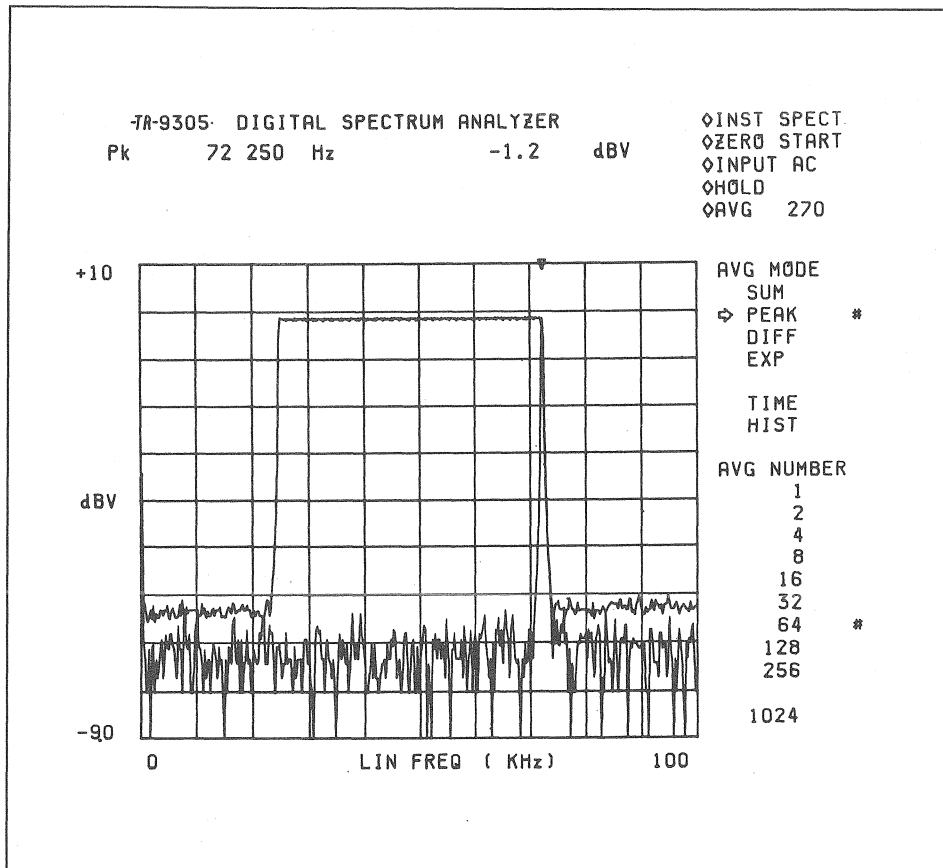

Computation mode

Computation of time-domain data:

Arithmetic operation is possible for the time-domain data in the dual display mode.

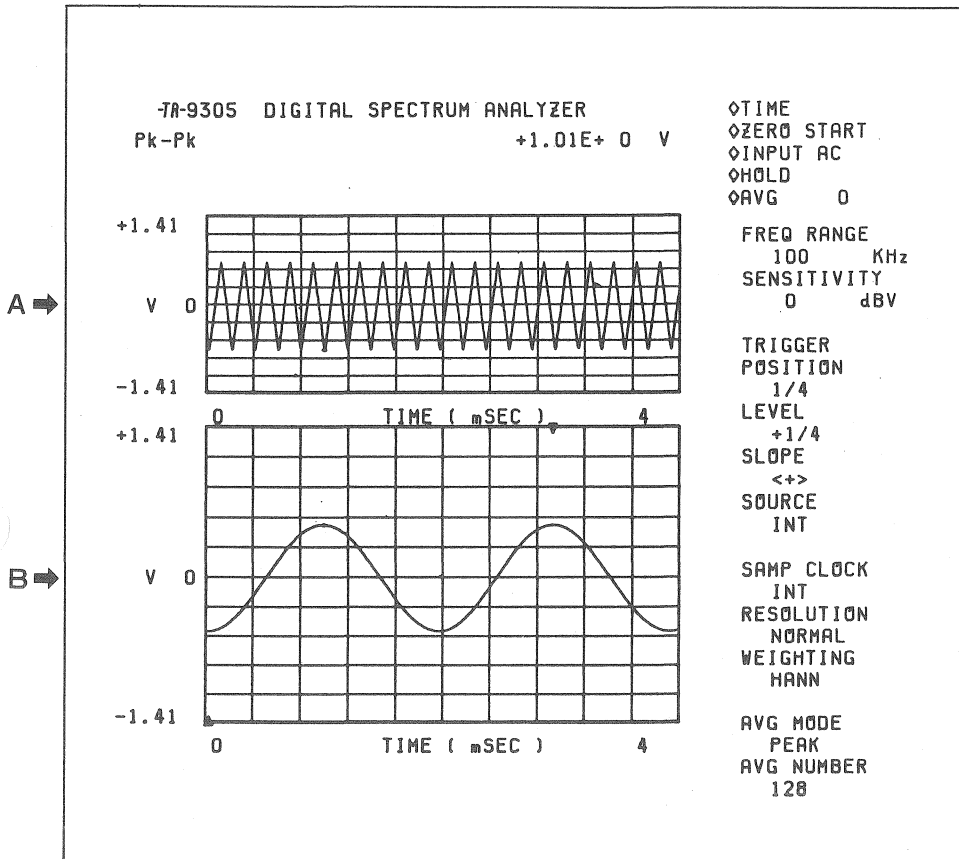

↓ A + B = C

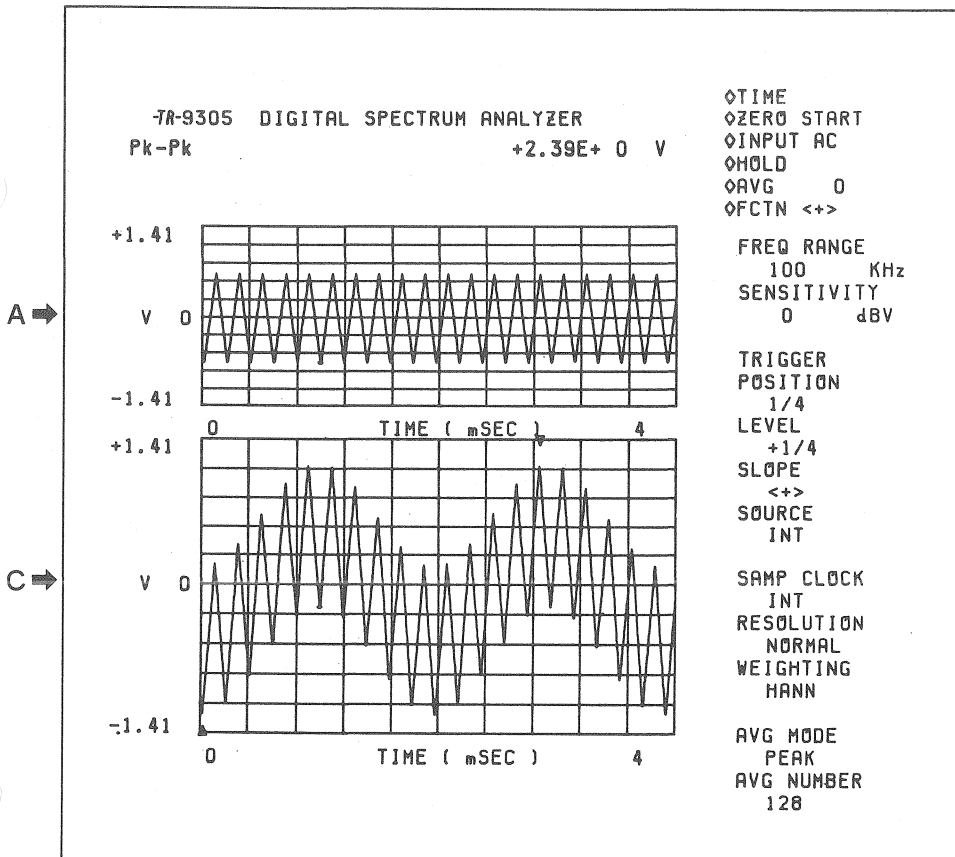

This display shows addition of the above data A and B to obtain the result, which is displayed as data C.

Computation mode

Computation of amplitude-domain data:

Arithmetic operation is possible for the amplitude-domain data in the dual display mode.

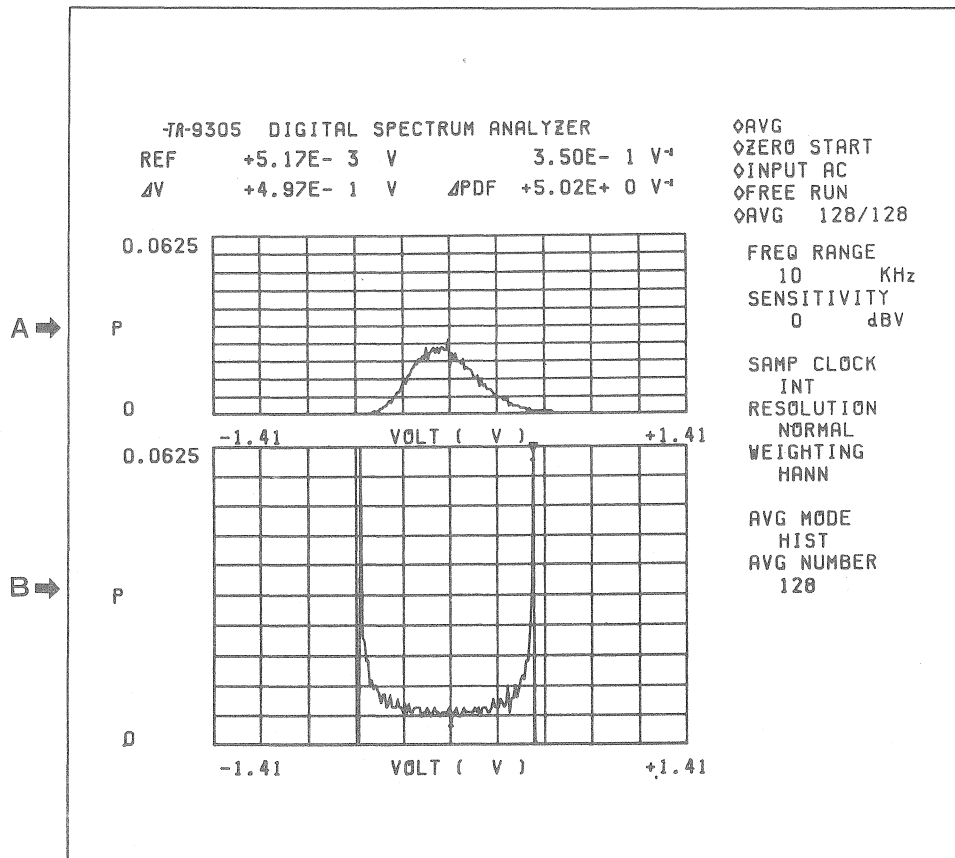

↓ A + B = C

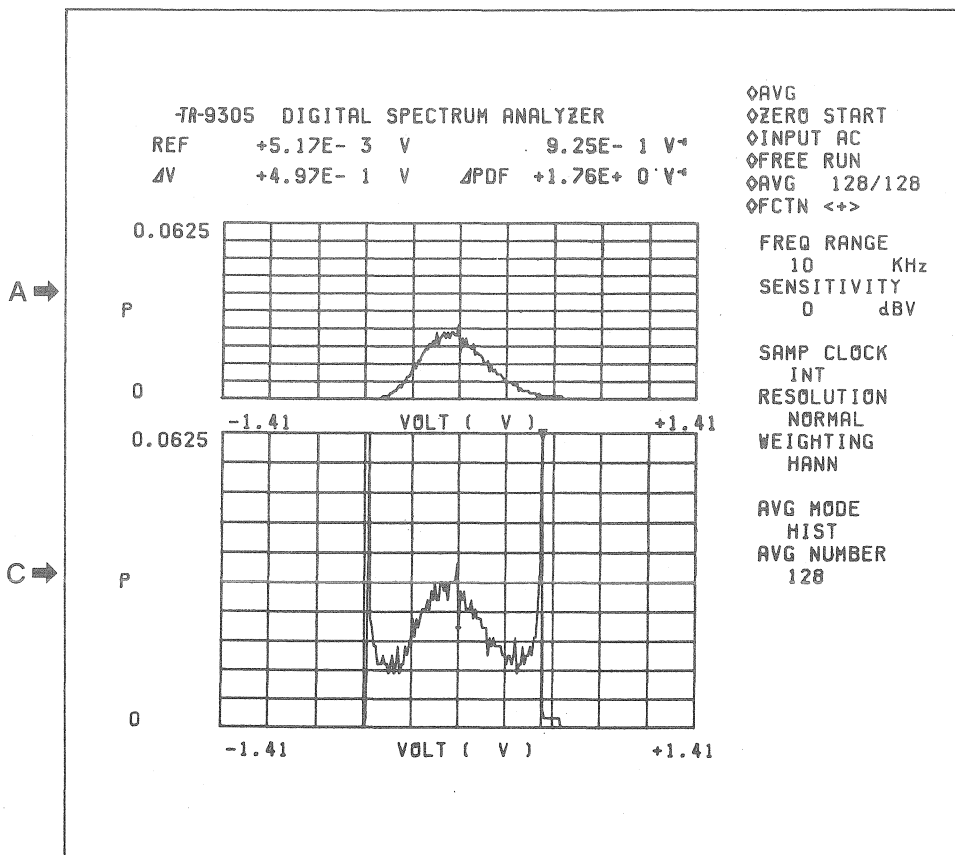

This display shows addition of the above data A and B to obtain the result, which is displayed as data C.

Computation mode

Computation of frequency-domain data:

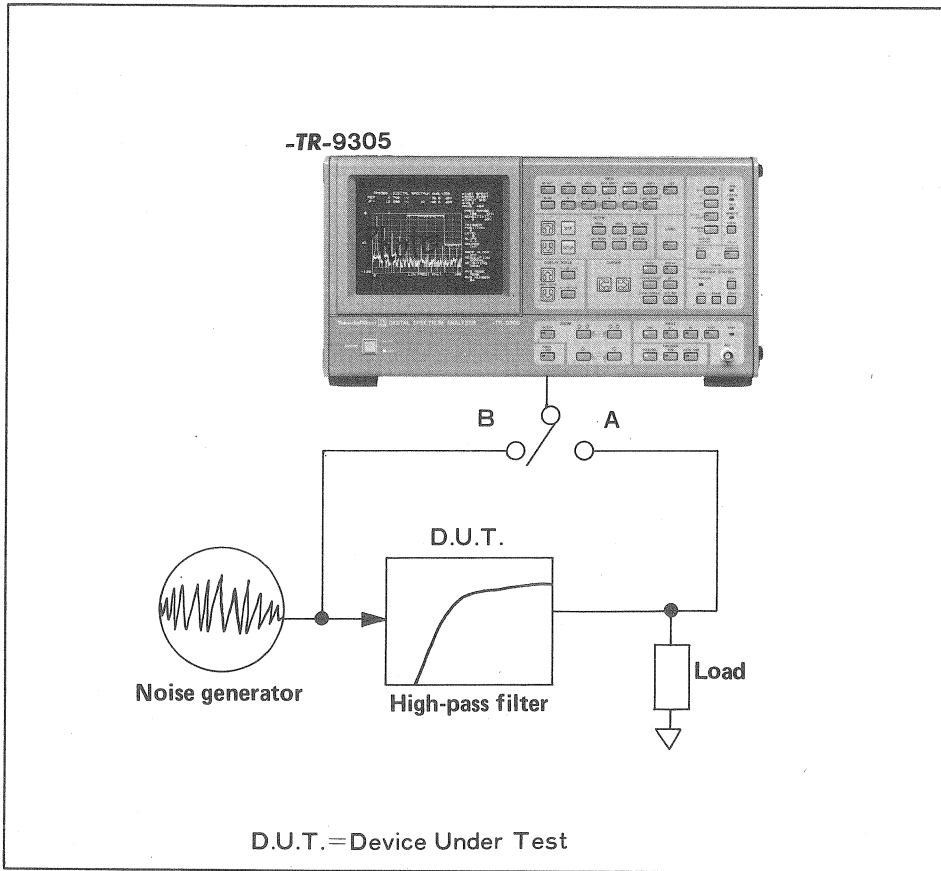

The transfer function of a device under test, a high-pass filter in this example, is analyzed.

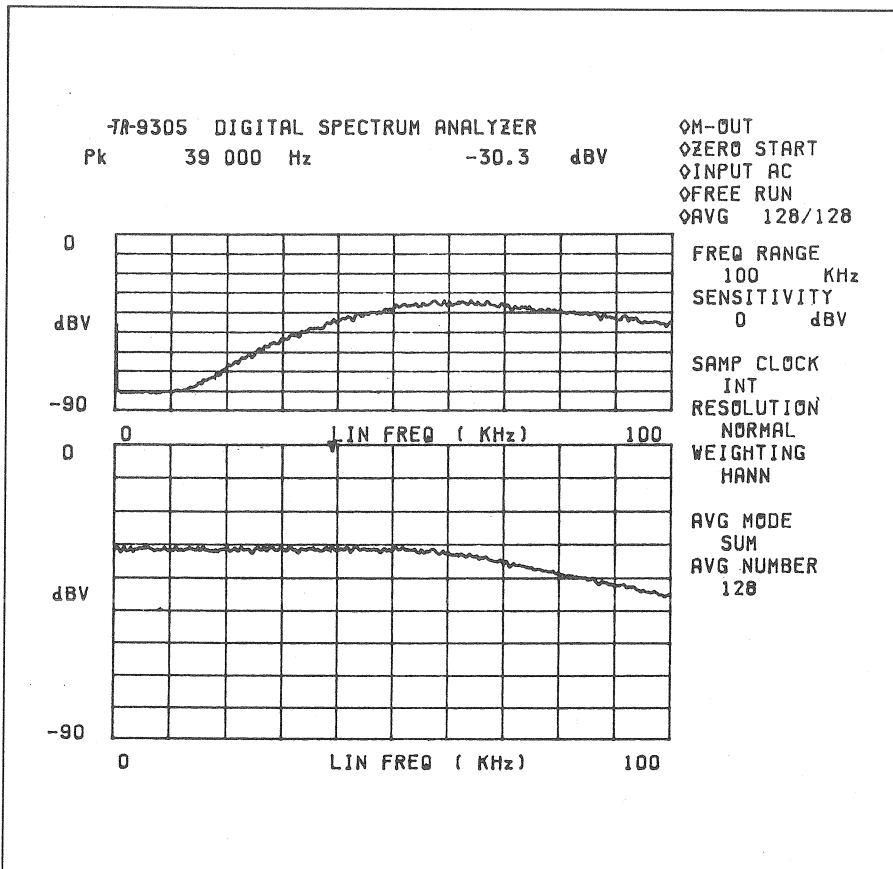

This display shows that the output of the signal source noise generator decreases in the higher frequency range.

- A: High-pass filter output
- B: Noise generator output (input of the high-pass filter)

Computation mode

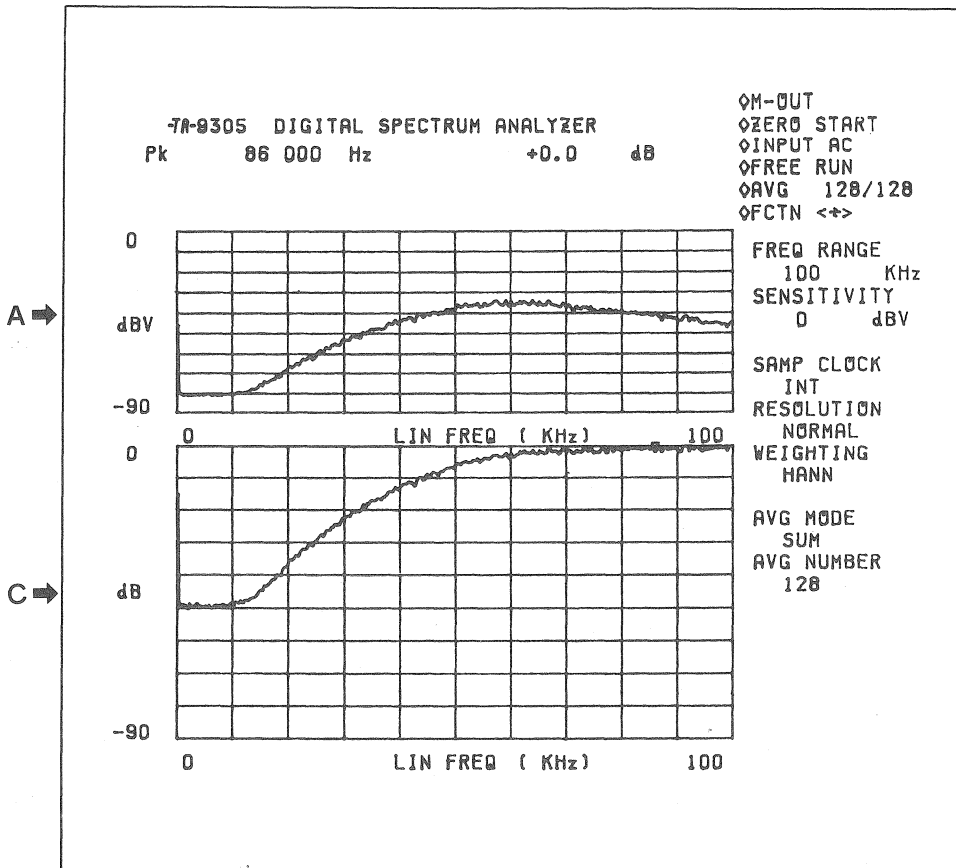

$$A \div B = C$$

Data A is divided by data B to obtain data C, which signifies the transfer function of the high-pass filter.

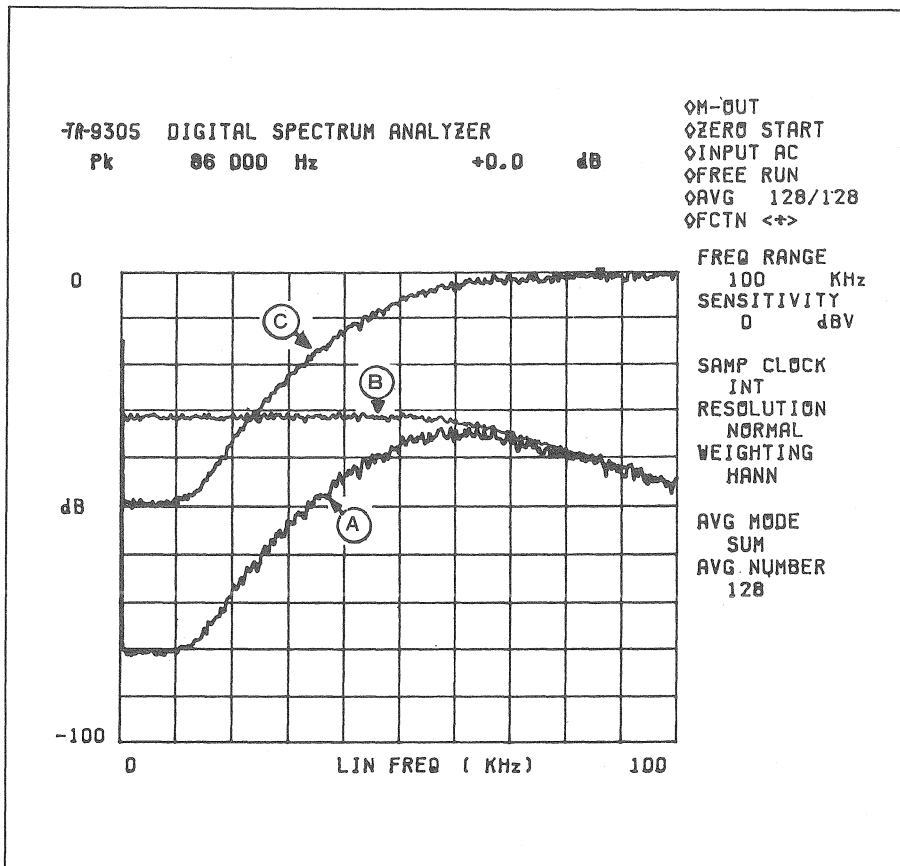

This figure shows an overlapped record of three data:

- A: High-pass filter output
- B: High-pass filter input (noise generator output)
- C: Transfer function of the high-pass filter

Recording by X-Y recorder

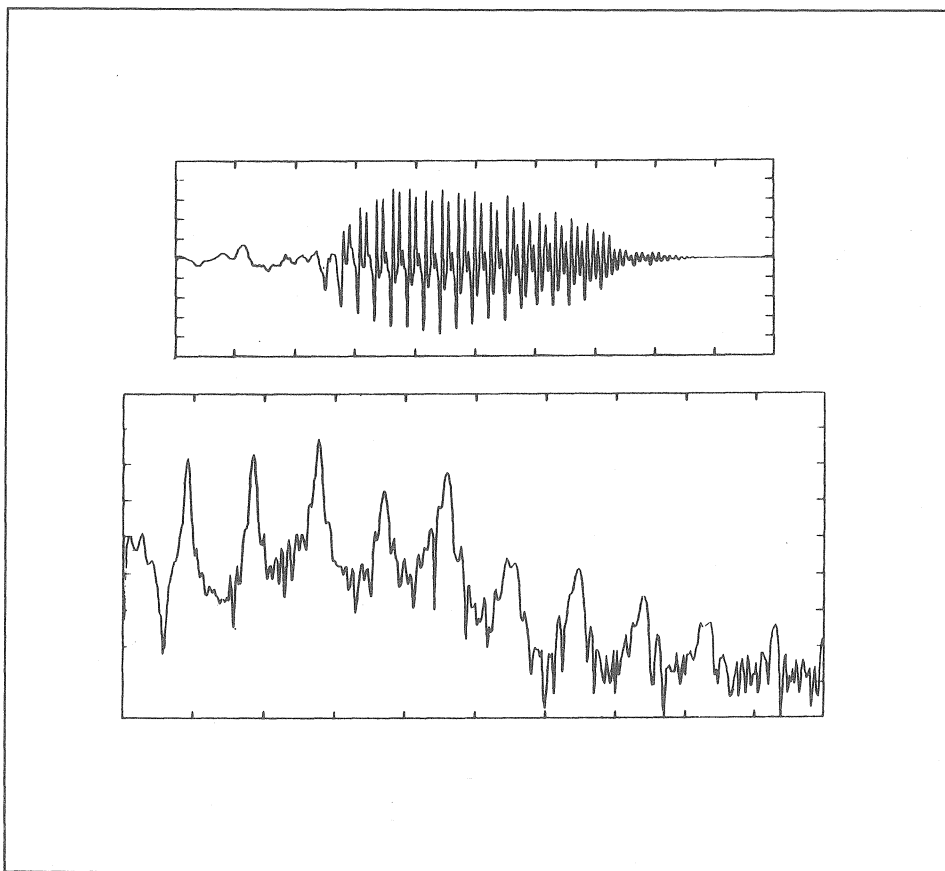

Dual display recording

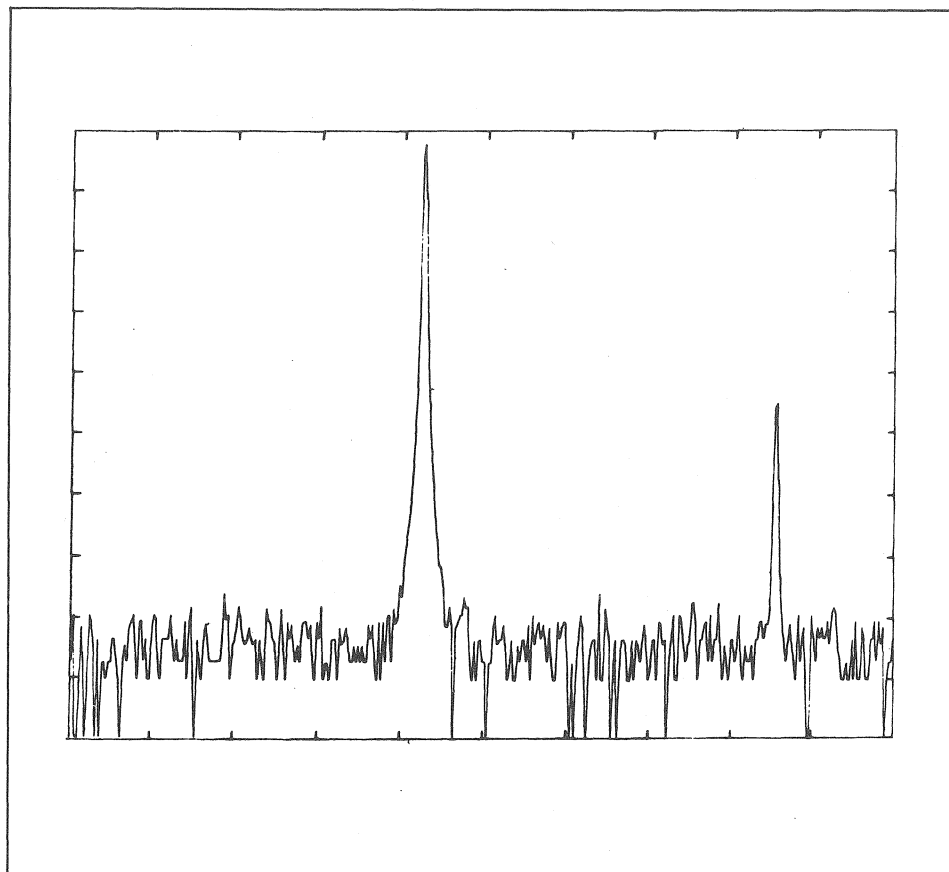

Single display recording



**Takeda Riken
Industry Co., Ltd.**

Address: 1-32-1, Asahi-cho, Nerima-ku, Tokyo, Japan 176
Tel: TOKYO 930-4111 Cable Address: TRITRONICS TOKYO
Telex: 272-2140

Your Local Representative _____

**FEDERAL
TRADE**

FILIALE DI ROMA
VIA CIPRIANO FACCHINETTI 13 - 00159 ROMA
☎ (06) 43.91.800

AGENZIA PER BRESCIA E TRE VENEZIE:
DITTA ING. GIANFRANCO ABELA
VIA DUCCO 1 - 25100 BRESCIA
☎ (030) 308.416

MILANO SAN FELICE - TORRE 8 - 20090 SEGRATE (MILANO) ITALY
☎ (02) 753.0315 / 753.0497 - TELEX 310108